



High Performance, Broadband Network Analysis Solutions

ME7838A Series Vector Network Analyzers

Broadband VNA System 70 kHz to 110 (125) GHz

The ME7838A broadband VNA system provides single sweep coverage from 70 kHz to 110 GHz and is operational from 40 kHz to 125 GHz. It consists of the following items:

- MS4647A VectorStar VNA, 70 kHz to 70 GHz with Option 007, Option 070, and Option 080/081
- 3739B Broadband Millimeter-Wave Test Set and Interface Cables
- 3743A Millimeter-Wave Modules, 2 each

Broadband/Millimeter-Wave System Options

- MS4640A-002, Time Domain
- MS4640A-041, Noise Figure
- MS4640A-051, External VNA Direct Access Loops
- MS4640A-061, Active Measurement Suite, with 2 Attenuators
- MS4640A-062, Active Measurement Suite, with 4 Attenuators

Millimeter Waveguide VNA System 50 GHz to 750 GHz (1.1 THz)

The ME7838A Millimeter-Wave configuration provides waveguide output from 50 GHz to 750 GHz (1.1 THz) in waveguide bands. The system can extend the broadband system or be configured to operate only as a waveguide system. It consists of the following items:

- MS464xA VectorStar VNA, with Option 007 and Option 082/083
- 3739B Broadband/Millimeter-Wave Test Set and Interface Cables
- Millimeter-Wave modules, 2 each

- SC8215 and SC7287 Kelvin Bias Tees
- 3744A-Rx, 30 to 125 GHz mm-Wave Receiver for Noise Figure and mm-Wave Antenna Measurements
- 3744A-EE, 56 to 95 GHz WR-12 Waveguide Module
- 3744A-EW, 65 to 110 GHz WR-10 Waveguide Module

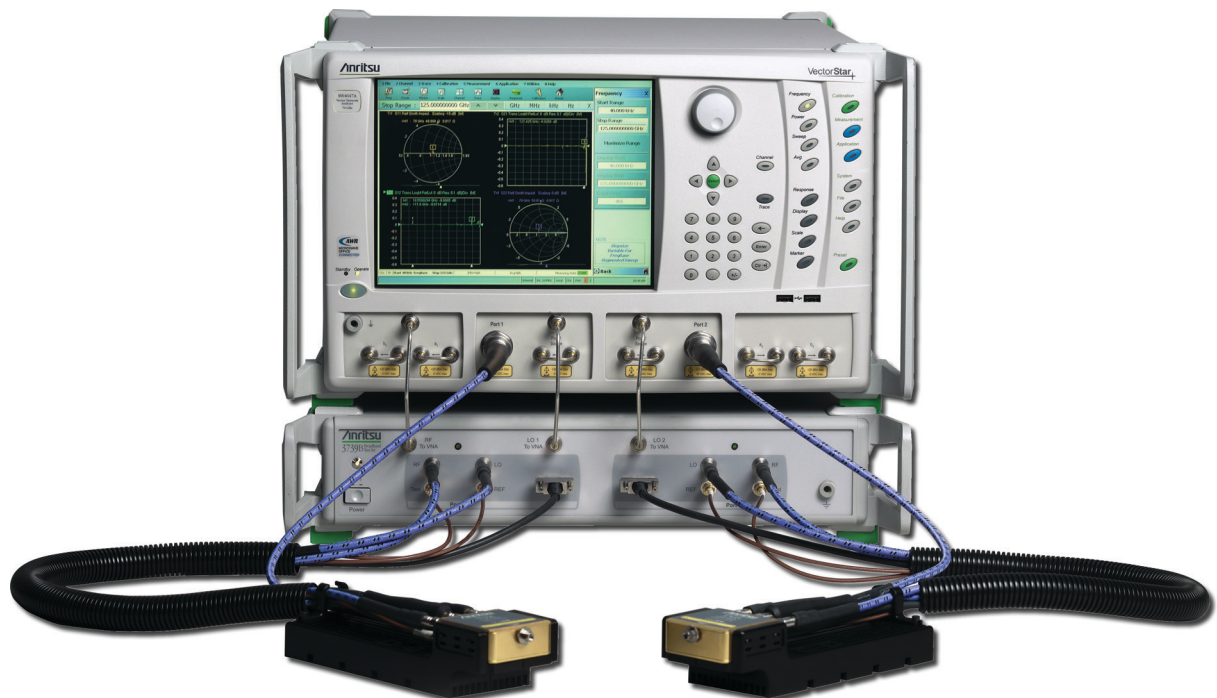

VectorStar ME7838A Broadband System

Description	Page
1. Definitions	2
2. Specifications for Broadband Configuration	3
3. Specifications for Waveguide Band Configuration	12
4. VectorStar ME7838A Waveguide Bands from 50 GHz to 750 GHz (1.1 THz).	21
5. Standard Capabilities for All Configurations	25
6. Mechanical and Environmental	25
7. Calibration and Correction Capabilities	26
8. Mechanical Calibration/Verification Kits	27
9. Test Port Cables	28
10. Precision Adapters, Attenuators, and Other Components	28
11. Warranty	29
12. Ordering Information	29

1. Definitions

	All specifications and characteristics apply under the following conditions, unless otherwise stated:
Warm-Up Time	After 90 minutes of warm-up time, where the instrument is left in the ON state.
Temperature Range	Over the 25 °C ± 5 °C temperature range.
Error-Corrected Specifications	For error-corrected specifications, over 23 °C ± 3 °C, with < 1 °C variation from calibration temperature. For error-corrected specifications are warranted and include guard bands, unless otherwise stated.
Typical Performance	"Typical" specifications describe expected, but not warranted, performance based on sample testing. Typical performance indicates the measured performance of an average unit and do not guarantee the performance of any individual product. "Typical" specifications do not account for measurement uncertainty and are shown in parenthesis, such as (-102 dB), or noted as Typical.
User Cables	Specifications do not include effects of any user cables attached to the instrument.
Discrete Spurious Responses	Specifications may exclude discrete spurious responses.
Internal Reference Signal	All specifications apply with internal 10 MHz Crystal Oscillator Reference Signal.
Characteristic Performance	Characteristic performance indicates a performance designed-in and verified during the design phase. It does include guard-bands and is not covered by the product warranty.
Below 300 kHz	All uncertainties below 300 kHz are typical.
Recommended Calibration Cycle	12 months
Interpolation Mode	All specifications are with Interpolation Mode Off.
Specifications Subject to Change	All specifications subject to change without notice. For the most current data sheet, please visit the Anritsu web site at www.anritsu.com .

2. Specifications for Broadband Configuration

2.1 ME7838A Broadband System Configuration

ME7838A Broadband Hardware Configuration

The ME7838A broadband VNA system provides single sweep coverage from 70 kHz to 110 GHz and is operational from 40 kHz to 125 GHz. It consists of the following items:

VNA	MS4647A VectorStar VNA, 70 kHz to 70 GHz with Option 007, Option 070, and Option 080/081
Test Set	3739B Broadband Test Set and interface cables
mm-Wave Modules	3743A Millimeter-Wave Modules, 2 each

ME7838A Broadband System Major Options

The major ME7838A broadband VNA system options are:

Option 002	MS4640A-002, Time Domain
Option 041	MS4640A-041, Noise Figure
Option 051	MS4647A-051, External VNA Direct Access Loops
Option 061	MS4647A-061, Active Measurement Suite, with 2 Attenuators
Option 062	MS4647A-062, Active Measurement Suite, with 4 Attenuators
Bias Tees	SC8215 and SC7287 Kelvin Bias Tees

2.2 System and Receiver Dynamic Range, Noise Floor (Excludes localized spurious responses and crosstalk)

System Dynamic Range	System dynamic range is measured as the difference between maximum port power and the RMS noise floor in a 10 Hz bandwidth and no averaging (ports terminated).
Noise Floor	Noise floor is calculated as the difference between maximum rated port power and system dynamic range.
Receiver Dynamic Range	Receiver Dynamic Range is calculated as the difference between the receiver compression level and the noise floor at Ports 1 or 2.
Normalizing Measurement	Normalizing measurement made with a through line connection, with its effects compensated for. The cables between the VNA and the 3743A modules are assumed to be the 806-206 1.85 mm cable (61 cm, 24 in long) or the 806-209 1.85 mm cable (91 cm, 36 in long). All figures are typical.

Frequency Range	System Dynamic Range (dB) ^a		Receiver Dynamic Range (dB) ^a		Noise Floor (dBm) ^a	
	ME7838A	ME7838A Option 062	ME7838A	ME7838A Option 062	ME7838A	ME7838A Option 062
70 to 300 kHz	93	90	89	86	-83	-80
0.3 to 2 MHz	103	100	103	102	-93	-90
2 to 10 MHz	115	112	115	114	-105	-102
0.01 to 2.5 GHz	120	116	121	122	-110	-109
2.5 to 24 GHz	110	105	121	121	-110	-108
24 to 54 GHz	110	107	124	123	-114	-113
54 to 60 GHz	108	108	122	122	-112	-112
60 to 67 GHz	108	108	117	117	-107	-107
67 to 80 GHz	108	108	120	120	-110	-110
80 to 85 GHz	107	107	123	123	-113	-113
85 to 90 GHz	107	107	121	121	-111	-111
90 to 95 GHz	109	109	121	121	-111	-111
95 to 105 GHz	107	107	117	117	-107	-107
105 to 110 GHz	109	109	122	122	-112	-112
110 to 120 GHz ^b	107	107	115	115	-110	-110
120 to 125 GHz ^b	104	104	112	112	-107	-107

a. Excludes localized spurious responses and crosstalk.

b. 110 to 125 GHz frequency range is available as operational.

2.3 Test Port Power, Receiver Compression

Port power control is provided by the base VNA for frequencies below 54 GHz, and by the 3743A mm-Wave module for frequencies greater than 54 GHz. Receiver compression point is defined as the port power level beyond which the response may be compressed more than 0.2 dB relative to normalization level. 10 Hz IF bandwidth used to remove trace noise effects. All typical.

Frequency Range	Port Power		Receiver Compression ^a	
	Max Power ME7838A	Max Power ME7838A Option 062	Compression ME7838A	Compression ME7838A Option 062
70 to 300 kHz	10	10	6	6
0.3 to 2 MHz	10	10	10	12
2 to 10 MHz	10	10	10	12
0.01 to 2.5 GHz	10	7	11	13
2.5 to 24 GHz	0	-3	11	13
24 to 54 GHz	-4	-6	10	10
54 to 60 GHz	-4	-4	10	10
60 to 67 GHz	1	1	10	10
67 to 80 GHz	-2	-2	10	10
80 to 85 GHz	-6	-6	10	10
85 to 90 GHz	-4	-4	10	10
90 to 95 GHz	-2	-2	10	10
95 to 105 GHz	0	0	10	10
105 to 110 GHz	-3	-3	10	10
110 to 120 GHz ^b	-3	-3	5	5
120 to 125 GHz ^b	-3	-3	5	5

a. Using the 806-206 1.85 mm (61 cm, 24 in long) test port cables or the 806-209 1.85 mm (91 cm, 36 in long) test port cables between the VNA and the 3743A mm-Wave modules.

b. 110 to 125 GHz frequency range is available as operational.

Power Range, Accuracy, Linearity, and Resolution

Accuracy is defined at -10 dBm or max rated power, whichever is lower. Linearity is defined as the incremental error between the accuracy test power level and 5 dB below. Typical.

Frequency	Range (dB)		Accuracy (dB)	Linearity (dB)	Resolution (dB)
	ME7838A	ME7838A Option 062			
70 to 300 kHz	-25 to +10	-85 to +10	±1.5	±1.5	0.01
0.3 to 2 MHz	-25 to +10	-85 to +10	±1.5	±1.5	0.01
2 to 10 MHz	-25 to +10	-85 to +10	±1.5	±1.5	0.01
.01 to 2.5 GHz	-25 to +10	-85 to +8	±1.0	±1.0	0.01
2.5 to 24 GHz	-25 to 0	-85 to -3	±1.0	±1.0	0.01
24 to 54 GHz	-30 to -4	-90 to -6	±1.5	±1.0	0.01
54 to 60 GHz	-55 to -4	-55 to -4	±2.0	±1.5	0.01
60 to 67 GHz	-55 to +1	-55 to +1	±2.0	±1.5	0.01
67 to 80 GHz	-55 to -2	-55 to -2	±2.0	±1.5	0.01
80 to 85 GHz	-55 to -6	-55 to -6	±2.0	±1.5	0.01
85 to 90 GHz	-55 to -4	-55 to -4	±2.0	±1.5	0.01
90 to 95 GHz	-55 to -2	-55 to -2	±2.0	±1.5	0.01
95 to 105 GHz	-55 to 0	-55 to 0	±3.0	±2.0	0.01
105 to 110 GHz	-50 to -3	-55 to -3	±3.0	±2.0	0.01
110 to 120 GHz ^a	-40 to -3	-40 to -3	±4.0	±3.0	0.01
120 to 125 GHz ^a	-40 to -3	-40 to -3	±4.0	±3.0	0.01

a. 110 to 125 GHz frequency range is available as operational.

2.4 High Level Noise

Noise measured at 1 kHz IF bandwidth, at maximum power or compression limit (whichever is less), with through transmission. RMS. Typical.

Frequency (GHz)	Magnitude (dB)	Phase (deg.)
70 to 500 kHz	< 0.04	< 0.4
0.5 to 2 MHz	< 0.005	< 0.05
2 to 10 MHz	< 0.005	< 0.05
0.01 to 2.5	< 0.005	< 0.05
2.5 to 24	< 0.006	< 0.06
24 to 54	< 0.005	< 0.06
54 to 80	< 0.005	< 0.06
80 to 110	< 0.008	< 0.09
110 to 120 ^a	< 0.010	< 0.20
120 to 125 ^a	< 0.025	< 0.30

a. 110 to 125 GHz frequency range is available as operational.

2.5 Stability

Ratioed measurement at maximum leveled power and with nominally a full reflect or a stable thru over the normal specified temperature range. Typical.

Frequency (GHz)	Magnitude (dB/°C)	Phase (deg./°C)
70 to 300 kHz	< 0.04	< 0.4
0.3 to 2 MHz	< 0.04	< 0.4
2 to 10 MHz	< 0.04	< 0.4
0.01 to 2.5	< 0.03	< 0.3
2.5 to 24	< 0.03	< 0.3
24 to 54	< 0.03	< 0.4
54 to 80	< 0.03	< 0.4
80 to 110	< 0.03	< 0.5
110 to 120 ^a	< 0.06	< 1.0
120 to 125 ^a	< 0.1	< 1.0

a. 110 to 125 GHz frequency range is available as operational.

2.6 Frequency Resolution, Accuracy, and Stability

Resolution	Accuracy	Stability
1 Hz	$\pm 5 \times 10^{-7}$ Hz/Hz (at time of calibration)	< 5×10^{-9} /°C over 0 °C to 50 °C temperature < 1×10^{-9} /day aging, instrument on

2.7 Uncorrected (Raw) Port Characteristics

Typical performance with either ME7838A or ME7838A with Option 062.

Frequency (GHz)	Directivity (dB)	Port Match (dB)
<10 MHz	10 ^a	8
0.01 to 2.5	9 ^a	10
2.5 to 30	5 ^a	12
30 to 40	5 ^a	5
40 to 54	10	5
54 to 80	10	10
80 to 110	5	7
110 to 120 ^b	5	7
120 to 125 ^b	5	7

a. Raw directivity is degraded below 300 kHz, 2.2 to 2.5 GHz and in narrow bands within 10 to 34 GHz.

b. 110 to 125 GHz frequency range is available as operational.

2.8 Corrected System Performance and Uncertainties – SOLT/SSST

With 12-term concatenated SOLT and Triple Offset Short Calibration (SSST), using the 3656B W1 Calibration Kit. Typical.

Frequency (GHz)	Directivity (dB)	Source Match (dB)	Load Match (dB)	Reflection Tracking (dB)	Transmission Tracking (dB)
70 kHz to 10 MHz	36	36	36	± 0.1	± 0.1
0.01 to 2.5	40	41	40	± 0.05	± 0.03
2.5 to 20	40	41	40	± 0.05	± 0.05
20 to 67	38	41	38	± 0.05	± 0.07
67 to 95	37	42	37	± 0.05	± 0.07
95 to 110	35	35	35	± 0.05	± 0.07

Measurement Uncertainties – SOLT/SSST

The graphs give measurement uncertainties after the above calibration. The errors are worst case contribution of residual directivity, load and source match, frequency response and isolation, network analyzer dynamic accuracy, and connector repeatability while noise effects are added on an RSS basis. 10 Hz IF Bandwidth is used. For transmission uncertainties, it is assumed that $s_{11} = s_{22} = 0$. For reflection uncertainties, it is assumed that $s_{21} = s_{12} = 0$. For other conditions, please use our free Exact Uncertainty calculator software, downloadable from the Anritsu web site at www.anritsu.com.

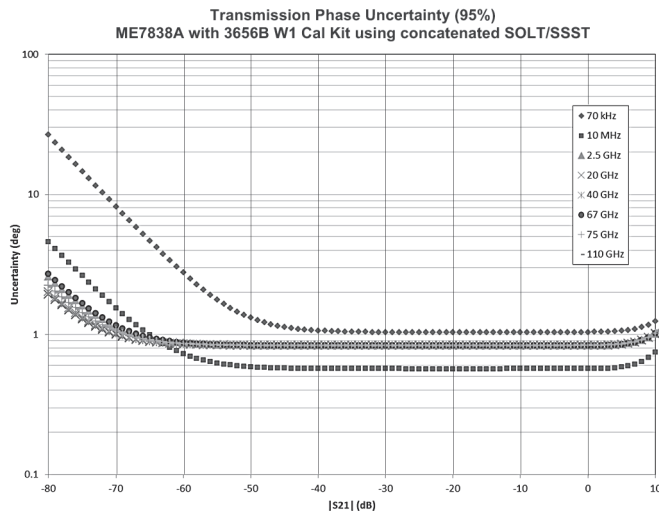
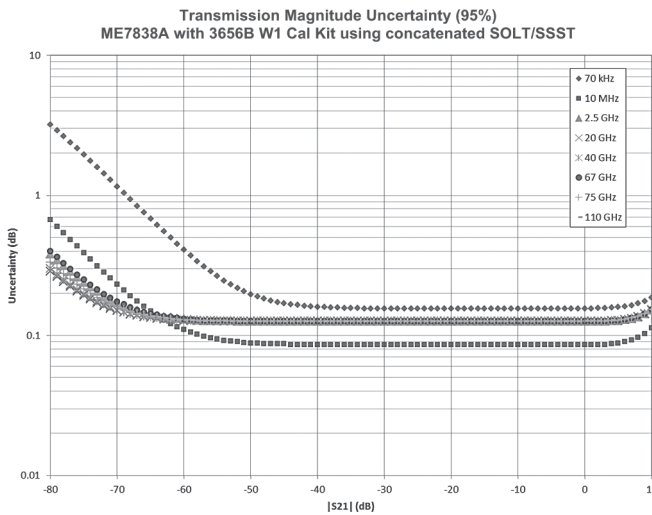
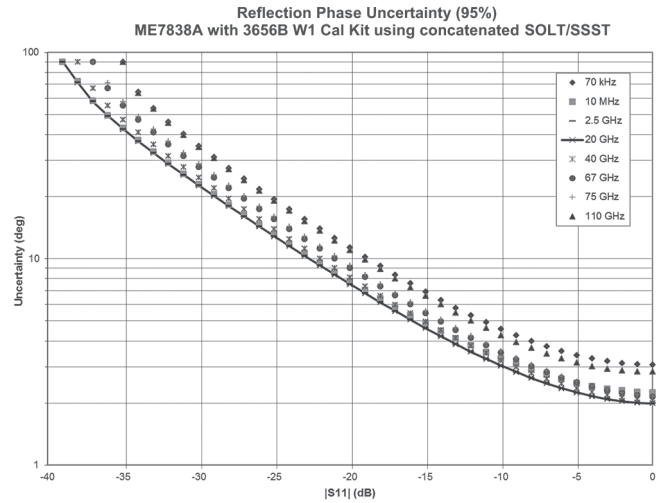
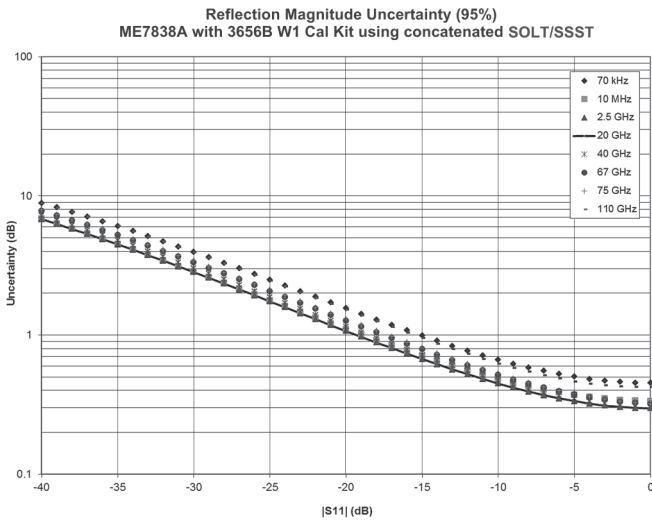

2.9 Corrected System Performance and Uncertainties – LRL/LRM

With 12 term LRL/LRM calibration using on-wafer substrate standards. Typical. Based on a typical vendor supplied impedance standard substrate.

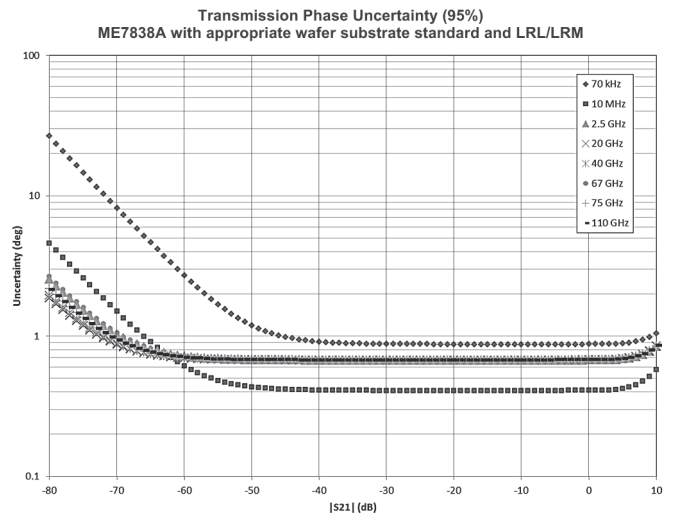
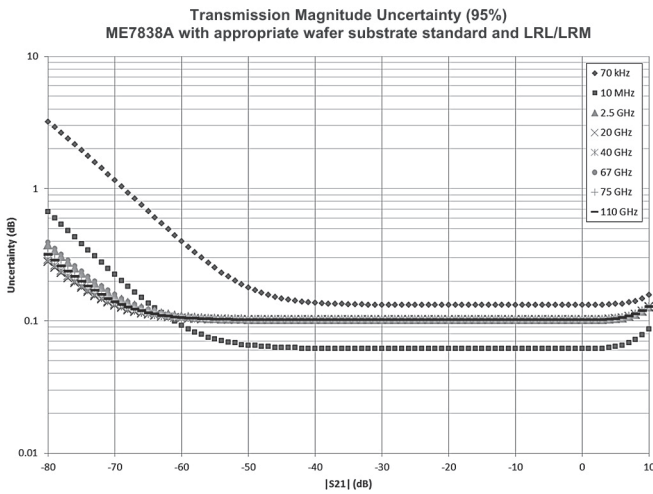
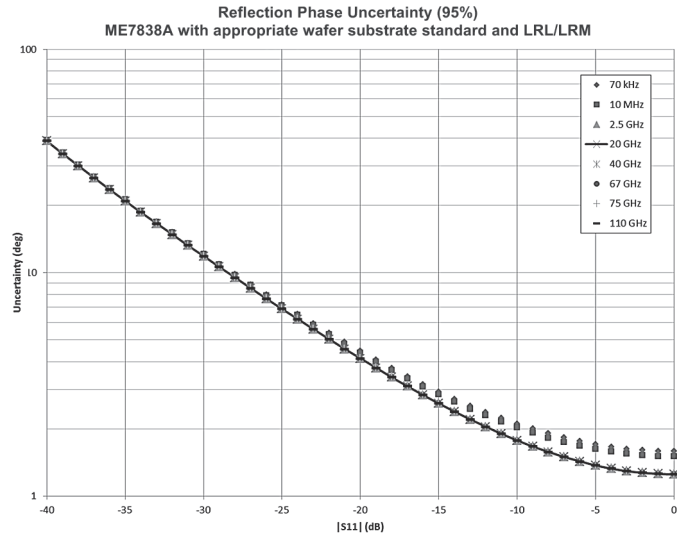
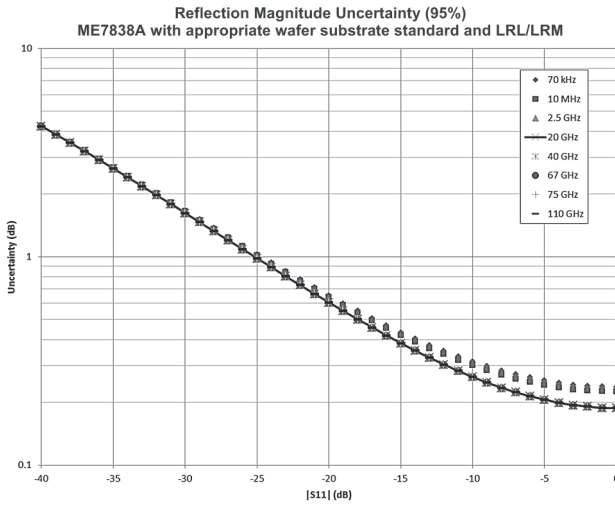

2.10 Measurement Time

Measurement times include sweep time, retrace time, and band-switching time. Typical.

Measurement Time (ms)

Full Band, 70 kHz to 110 GHz, Display ON, and ALC ON.

Calibration	IFBW	Measurement Time (ms) ^a			
		401 Points	1,601 Points	10,001 Points	25,000 Points
1-port calibration	1 MHz	80	100	350	700
	30 kHz	90	160	600	1500
	10 kHz	110	240	1100	2600
	1 kHz	470	1600	10,000	25,000
	10 Hz	47,000	160,000	1,000,000	2,500,000
2-port calibration	1 MHz	160	200	700	1400
	30 kHz	180	320	1200	3000
	10 kHz	220	480	2200	5200
	1 kHz	940	3200	20,000	50,000
	10 Hz	94,000	320,000	2,000,000	5,000,000

a. Measurement times are for ME7838A Broadband and ME7838A Millimeter-Wave Systems.

Measurement Time (ms) vs. System Dynamic Range (dB)

Full Band, Display ON, and ALC ON.

Calibration	401 Points Measurement Time	Achieved System Dynamic Range (Opt 062 at 54 GHz)	IFBW and Averaging Used
Uncorrected or 1-port calibration	110	77	10 kHz/no avg
	470	87	1 kHz/no avg
2-port calibration	220	77	10 kHz/no avg
	940	87	1 kHz/no avg

2.11 Block Diagram – ME7838A Broadband VNA System

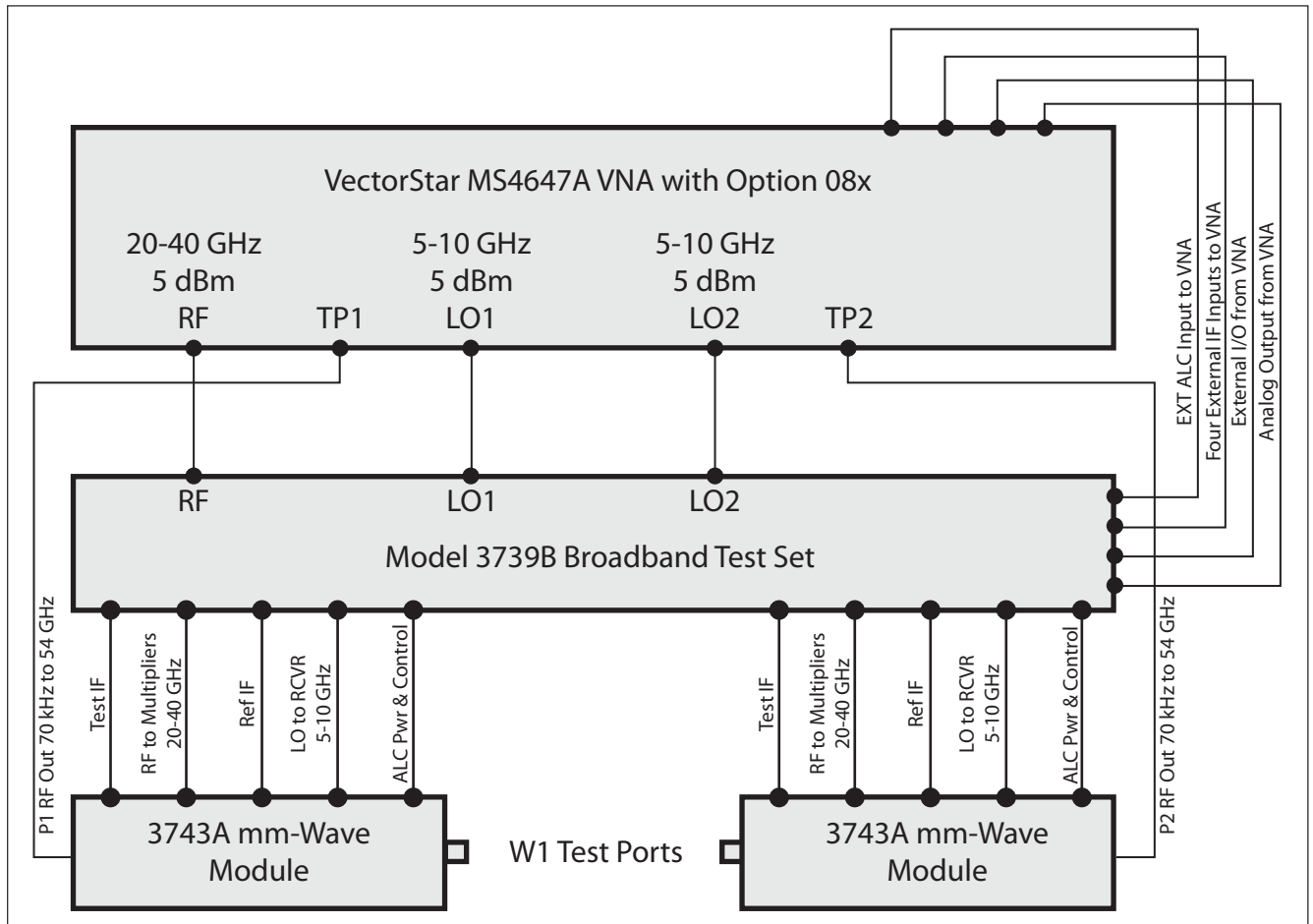

Broadband Configuration Block Diagram

2.12 SC8215 and SC7287 Kelvin Bias Tees

Provides Sense and Force SMC connections close to the mm-Wave module to minimize the IR drops associated with the impedances between the bias tee and the DUT.

Part Number	Description	Voltage	Current
SC8215	The SC8215 is a bias tee providing DC bias from 70 kHz to 110 GHz.	Max Voltage: 16 VDC	Max Current: 100 mA
SC7287	The SC7287 is a bias tee providing DC bias from 100 MHz to 110 GHz.	Max Voltage: 50 VDC	Max Current: 500 mA
Tri-Axial Output SMUs	For applications requiring Source Measure Units (SMU) with tri-axial outputs, a tri-axial (male) to SMC (male) cable is available, with the inner-shield isolated from ground at the bias tee SMC end, to float at the SMU guard potential. Check the accessories list for ordering information on page 30.		

2.13 Measurement Examples

The following figures are measurement examples of the ME7838A Broadband system performance.

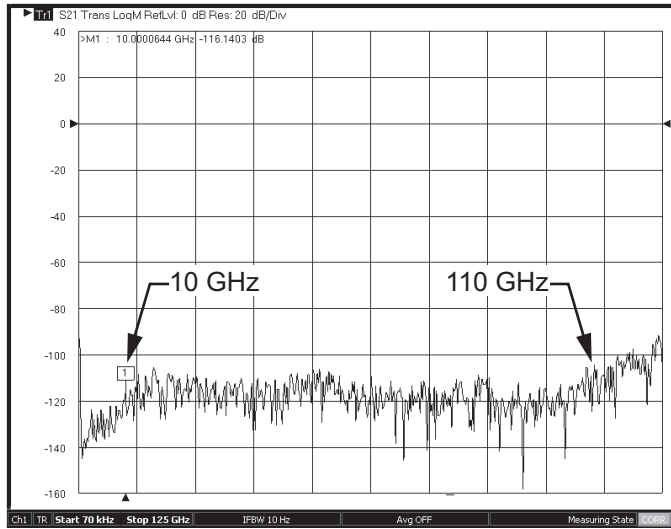

Dynamic range of ME7838A system at the W1 1 mm coaxial test port from 70 kHz to 125 GHz.

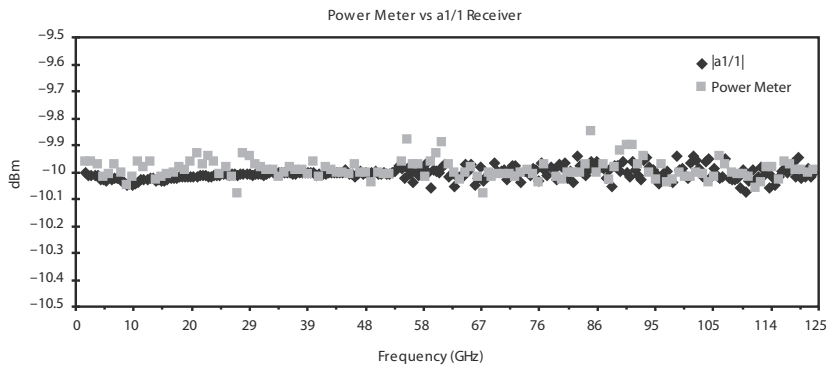

An example of power measurement agreement: power sensor vs. ME7838A a1 reference receiver.

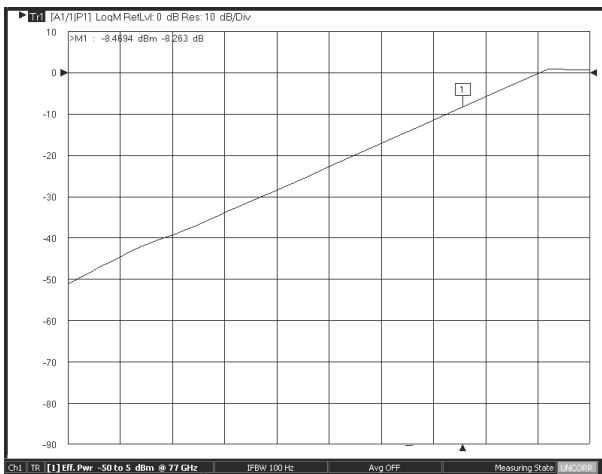

Power sweep range at 77 GHz. By using detection and power control inside the 3743A millimeter-wave module; improved accuracy, linearity and range can be achieved.

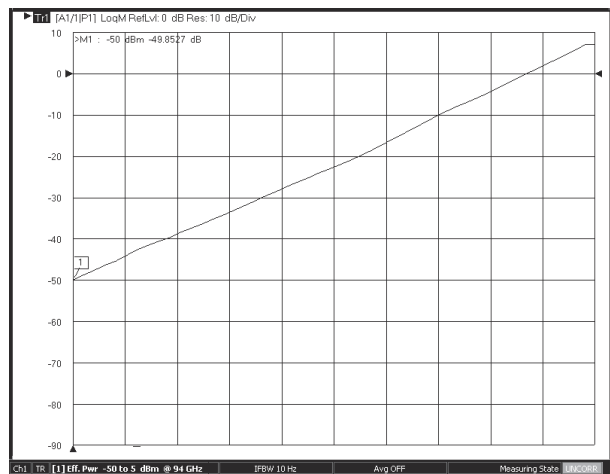

Power sweep range at 94 GHz demonstrating greater than 50 dB of control.

Example 24 hour vector reflect stability (high reflect)

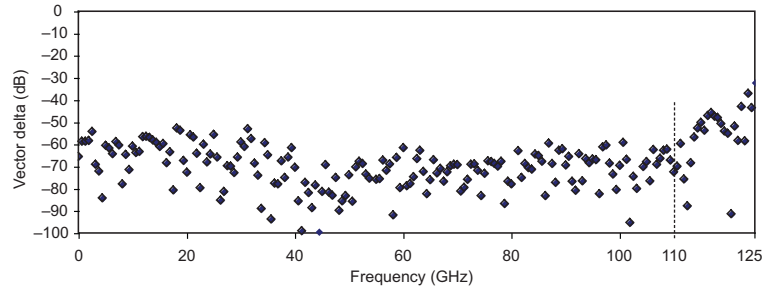

24 hour high reflect stability in vector delta format

Thru Line Transmission (24 Hours)

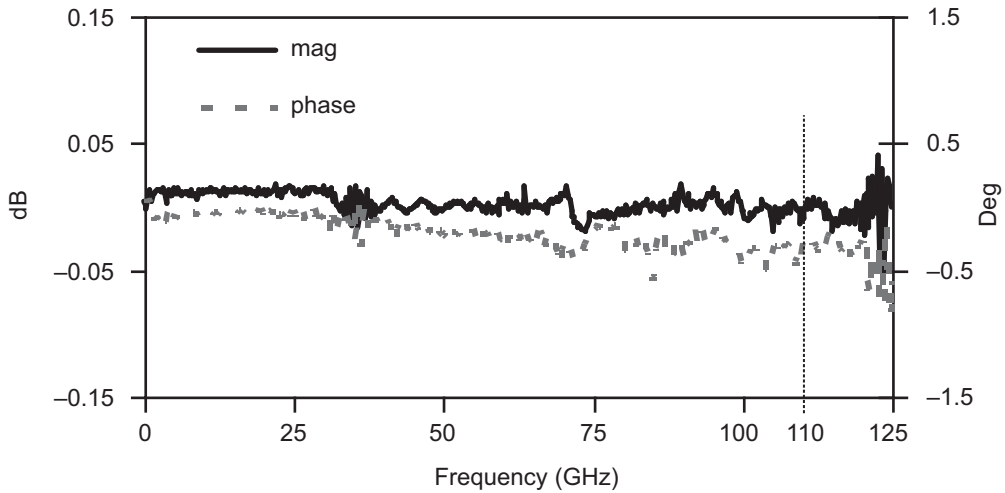

Thru line transmission stability up to 125 GHz

Thru Line Match (24 Hours)

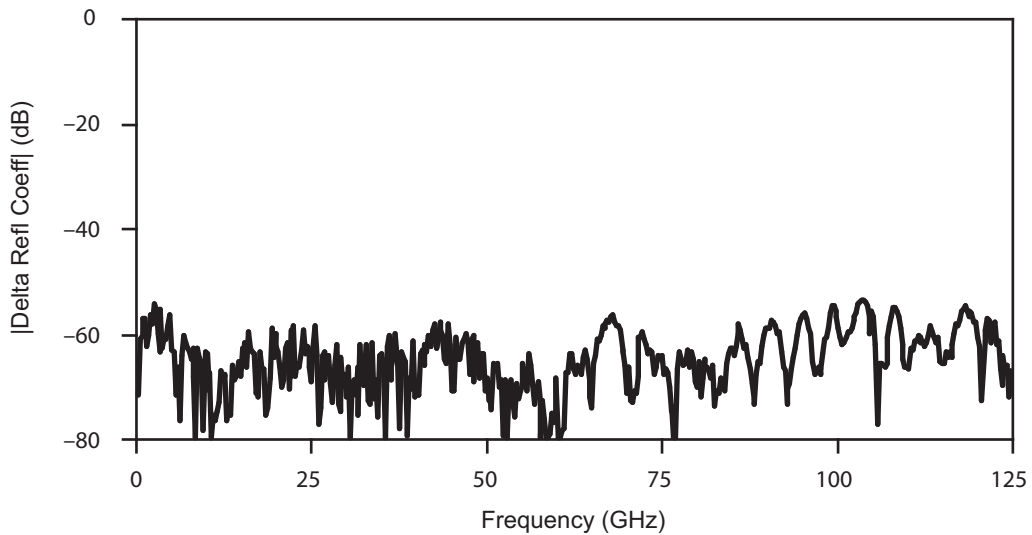

Example of vector delta thru line match after 24 hours

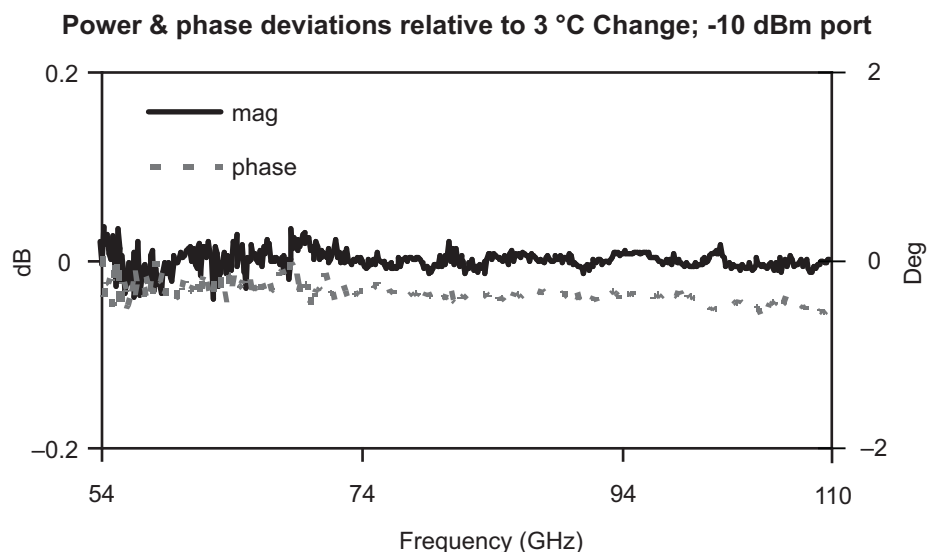
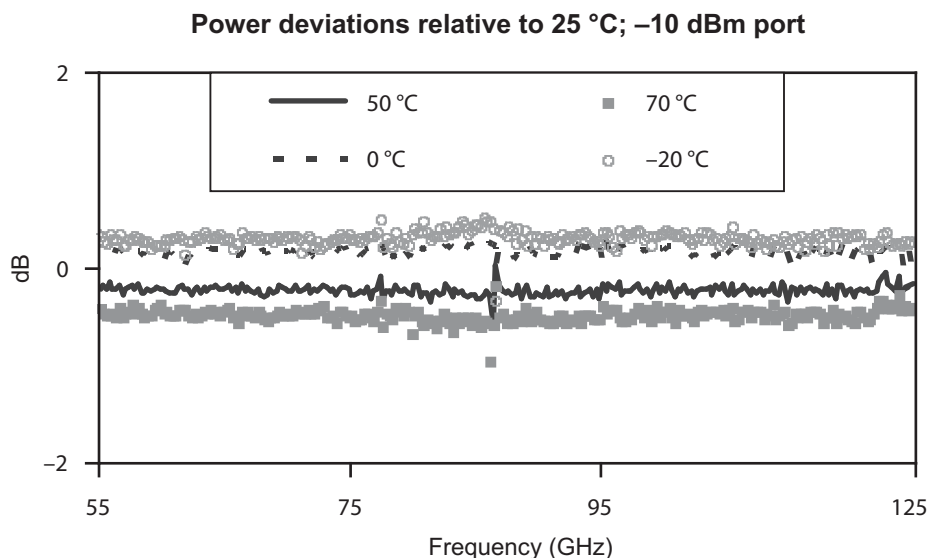

3. Specifications for Waveguide Band Configuration

3.1 ME7838A Millimeter-Wave VNA, Waveguide Bands

Three configurations are available for waveguide band operation for E and W bands when using the ME7838A system.

- First, the Anritsu 3743A Broadband Millimeter-Wave (mm-Wave) module can be adapted to waveguide measurements using waveguide adapters.
- Second, the Anritsu 3744A-EE or 3744A-EW millimeter-wave module can be used. These version modules operate in the extended E and W waveguide bands and are operational using the MS4644A, MS4645A, or MS4647A VectorStar (with options 08x and 007) and the 3739B broadband/millimeter-wave test set.
- The third configuration option is to use external millimeter-wave modules with any model VectorStar (with options 08x and 007) and the 3739B test set. For millimeter bands above 110 GHz either the OML or VDI modules may be used.

3.2 E and W Band Operation Using the 3743A, 3744A-EE, or 3744A-EW mm-Wave Module



3743A Millimeter-Wave Modules

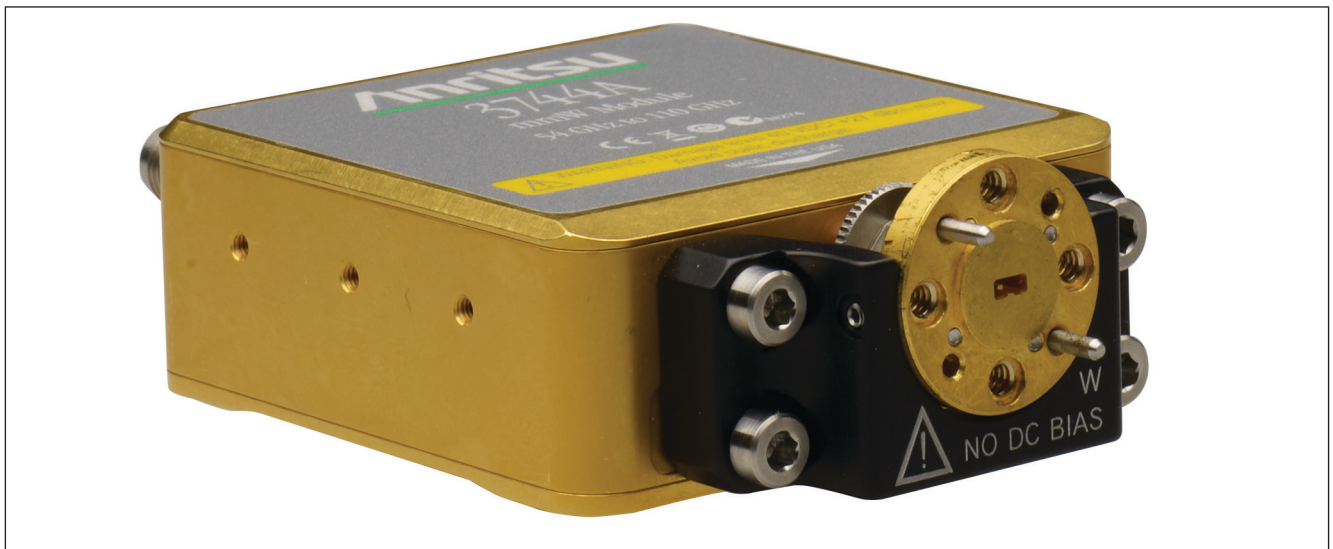

3744A-EE/3744A-EW Millimeter-Wave Module with Waveguide Adapter

The 3743A Broadband mm-Wave module can be adapted to a waveguide band output by adding an available waveguide band adapter and mounting flange. VectorStar menus automatically configure the system frequencies incorporating the 3743A module for banded operation. Using the 3743A modules provides the opportunity to sweep frequencies for broadband applications and quickly convert to waveguide configurations for banded measurements. The advantages of small compact modules with excellent RF performance and power range control can therefore be realized in both broadband and waveguide configurations when using the 3743A mm-Wave module. For systems where only waveguide band operation is required, the 3744A-EE or 3744A-EW mm-Wave module can be used.

The 3744A-EE or 3744A-EW mm-Wave module operates from 54 GHz to 110 GHz. The band supported is determined by the waveguide adapter connected to the 1 mm test port output of the 3744A-EE/EW module:

- 3744A-EE configures the module for Extended E Band
- 3744A-EW configures for Extended W Band

The RF input port of the 3744A-EE or 3744A-EW module is restricted below 54 GHz, however, the RF input port retains a DC connection to the 1 mm test port. Thus, the waveguide adapter can be removed for on-wafer applications from 54 GHz to 110 GHz operation and the on-wafer DUT can be biased through the RF input port.

Band	Frequency Range	Waveguide Flange	Transmission/Reflection Module
Ext-E	56 to 94 GHz ^a	WR-12	3744A-EE
Ext-W	65 to 110 GHz	WR-10	3744A-EW

a. Operational to 95 GHz.

3.3 Port Power, Noise Floor, Dynamic Range – 3744A-EE/3744A-EW mm-Wave Modules

System dynamic range is defined as the ratio of the source power to the noise floor.

Maximum Receiver Power is defined as the 0.2 dB compression point of the receiver at the waveguide port.

Receiver dynamic range is defined as the ratio of maximum receive power to the noise floor.

Noise Floor measurements are RMS, are made with no average in a 10 Hz IF bandwidth, and include an isolation calibration.

All figures are typical.

3744A-EE Extended-E Band (WR-12) Waveguide

Frequency Range (GHz)	Source Power (dBm)	Max. Receive Power (0.2 dB comp. pt.) (dBm)	Noise Floor (dBm)	System Dynamic Range (dB)	Receiver Dynamic Range (dB)
56 to 60	-5	11	-111	106	122
60 to 67	0	11	-106	106	117
67 to 80	-3	11	-109	106	120
80 to 85	-7	11	-112	115	123
85 to 90	-5	11	-110	105	120
90 to 94 ^a	-2	12	-105	103	117

a. Operational to 95 GHz.

3744A-EW Extended-W Band (WR-10) Waveguide

Frequency Range (GHz)	Source Power (dBm)	Max. Receive Power (0.2 dB comp. pt.) (dBm)	Noise Floor (dBm)	System Dynamic Range (dB)	Receiver Dynamic Range (dB)
65 to 67	0	11	-106	106	117
67 to 80	-3	11	-109	106	120
80 to 85	-7	11	-112	115	123
85 to 90	-5	11	-110	105	120
90 to 105	-2	12	-105	103	117
105 to 110	-7	12	-110	103	122

Power Range, Accuracy, Linearity, and Resolution

Accuracy is defined at -10 dBm or max rated power, whichever is lower. Linearity is defined as the incremental error between the accuracy test power level and 5 dB below. Typical.

Frequency (GHz)	Range (dBm)		Accuracy (dB)	Linearity (dB)	Resolution (dB)
	ME7838A	ME7838A Option 062			
54 to 60	-55 to -4	-55 to -4	± 2.0	± 1.5	0.01
60 to 67	-55 to 1	-55 to 1	± 2.0	± 1.5	0.01
67 to 80	-55 to -2	-55 to -2	± 2.0	± 1.5	0.01
80 to 85	-55 to -6	-55 to -6	± 2.0	± 1.5	0.01
85 to 90	-55 to -4	-55 to -4	± 2.0	± 1.5	0.01
90 to 105	-55 to 0	-55 to 0	± 3.0	± 2.0	0.01
105 to 110	-50 to -5	-50 to -5	± 3.0	± 2.0	0.01
110 to 120 ^a	-40 to -12	-40 to -12	± 4.0	± 3.0	0.01
120 to 125 ^a	-40 to -15	-40 to -15	± 4.0	± 3.0	0.01

a. 110 to 125 GHz frequency range is available as operational.

Alternatively, the V, E and W bands can be supported using external millimeter-wave modules such as the 3740/41A series modules available from Anritsu. For further description and specifications please refer to the VectorStar ME7828A Technical Data Sheet – 11410-00452 available at www.anritsu.com.

3.4 Corrected System Performance/Uncertainties – 3744A-EE/3744A-EW mm-Wave Modules

With 12-term Offset Short Sliding Load or LRL calibrations, using high precision waveguide sections and standards from the appropriate calibration kit.

3744A-EE Extended-E Band (WR-12) Waveguide – 56 GHz to 94 GHz

Calibration Type	Directivity (dB)	Source Match (dB)	Load Match (dB)	Reflection Tracking (dB)	Transmission Tracking (dB)
Offset Short	> 44	> 33	> 44	± 0.080	± 0.100
LRL	> 44	> 43	> 44	± 0.006	± 0.006

3744A-EW Extended-W Band (WR-10) Waveguide – 65 GHz to 110 GHz

Calibration Type	Directivity (dB)	Source Match (dB)	Load Match (dB)	Reflection Tracking (dB)	Transmission Tracking (dB)
Offset Short	> 40	> 30	> 46	± 0.080	± 0.100
LRL	> 40	> 40	> 46	± 0.006	± 0.006

Measurement Uncertainties – Extended-E Band – SSLT

The graphs give measurement uncertainties after the above calibration. The errors are worse case contribution of residual directivity, load and source match, frequency response and isolation, network analyzer dynamic accuracy, and connector repeatability. 10 Hz IF Bandwidth is used. For transmission uncertainties, it is assumed that $s_{11} = s_{22} = 0$. For reflection uncertainties, it is assumed that $s_{21} = s_{12} = 0$. All calibrations and measurements were performed at default port power. For other conditions, please use our free Exact Uncertainty Calculator software, available for download from the Anritsu web site at www.anritsu.com. Typical.

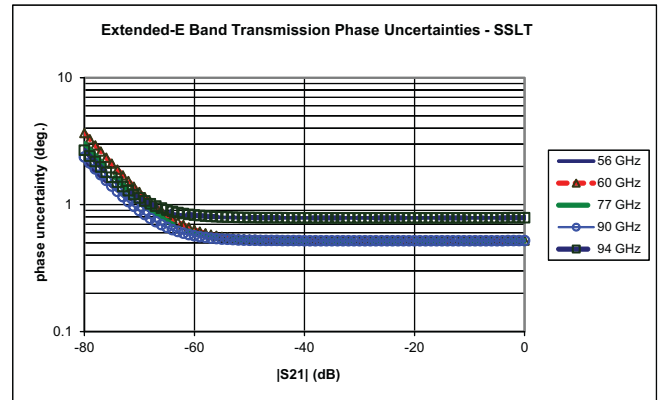
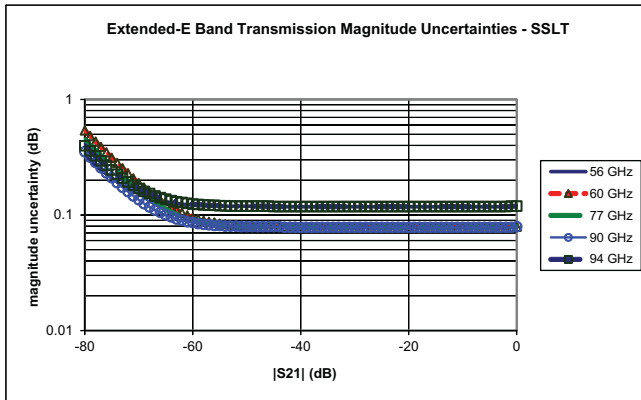
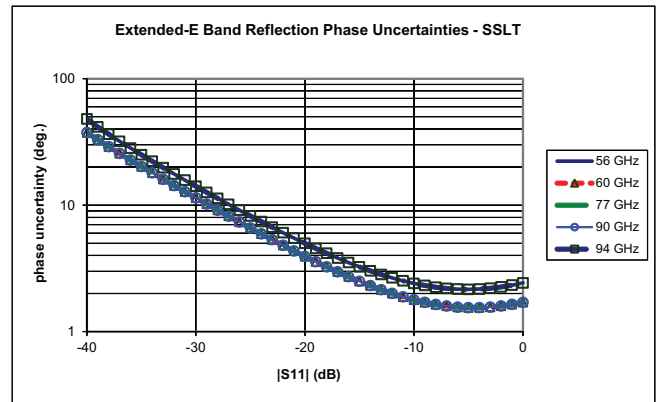
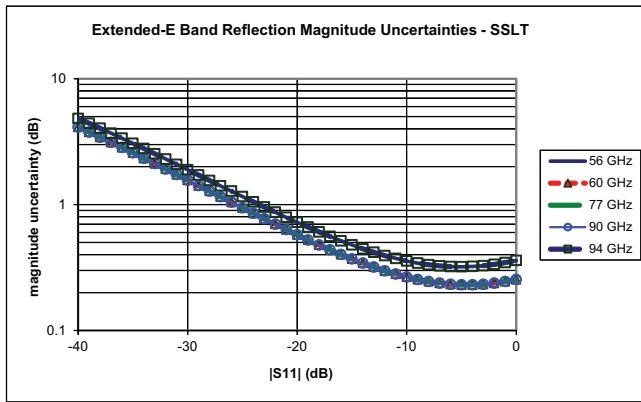

Measurement Uncertainties – Extended-E Band – LRL

The graphs give measurement uncertainties after the above calibration. The errors are worst case contribution of residual directivity, load and source match, frequency response and isolation, network analyzer dynamic accuracy, and connector repeatability. 10 Hz IF Bandwidth is used. For transmission uncertainties, it is assumed that $s_{11} = s_{22} = 0$. For reflection uncertainties, it is assumed that $s_{21} = s_{12} = 0$. All calibrations and measurements were performed at default port power. For other conditions, please use our free Exact Uncertainty Calculator software, available for download from the Anritsu web site at www.anritsu.com. Typical.

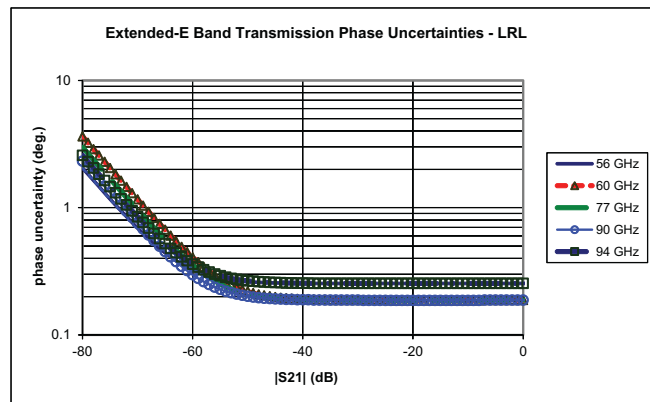
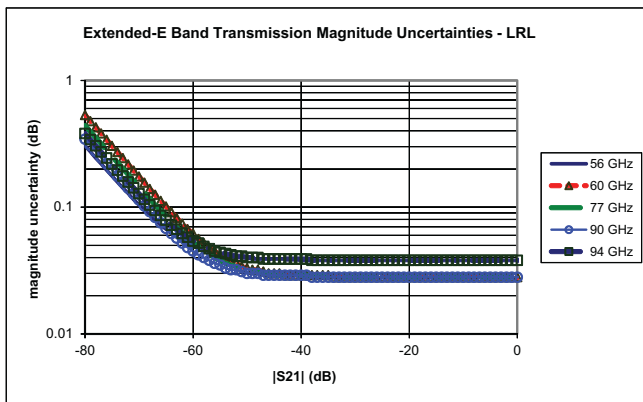
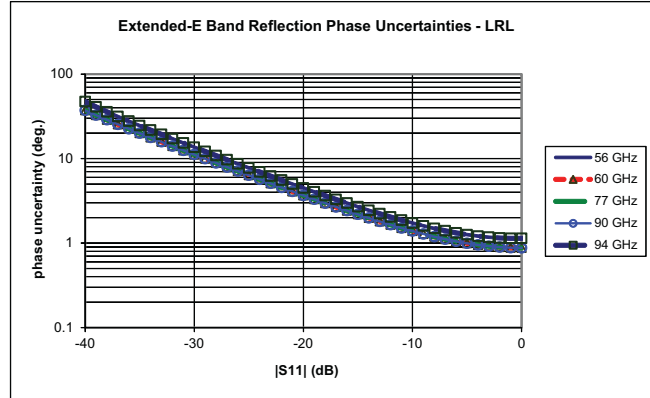
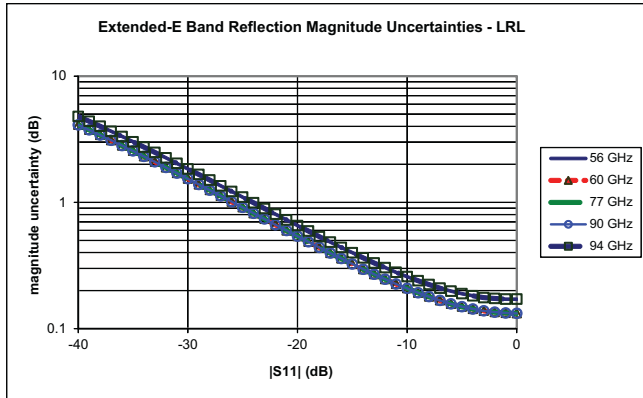

Measurement Uncertainties – Extended-W Band – SSLT

The graphs give measurement uncertainties after the above calibration. The errors are worst case contribution of residual directivity, load and source match, frequency response and isolation, network analyzer dynamic accuracy, and connector repeatability. 10 Hz IF Bandwidth is used. For transmission uncertainties, it is assumed that $s_{11} = s_{22} = 0$. For reflection uncertainties, it is assumed that $s_{21} = s_{12} = 0$. All calibrations and measurements were performed at default port power. For other conditions, please use our free Exact Uncertainty Calculator software, available for download from the Anritsu website at www.anritsu.com. Typical.

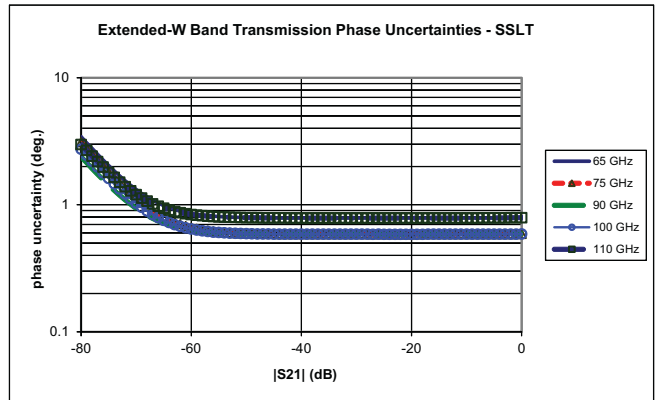
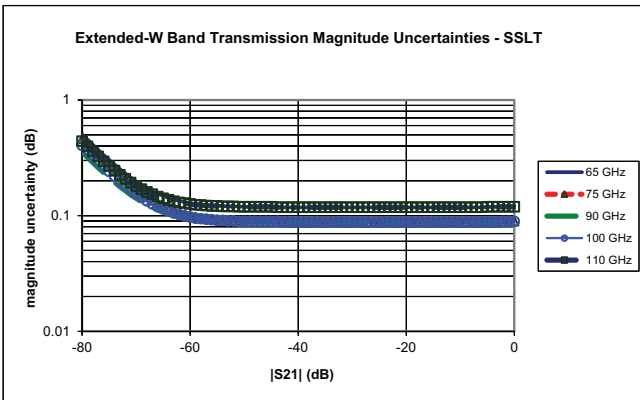
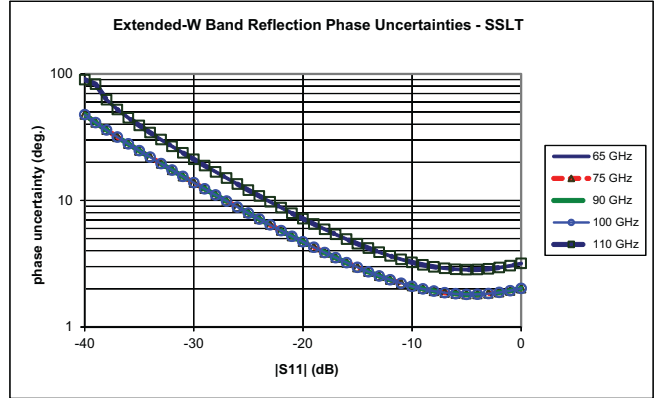
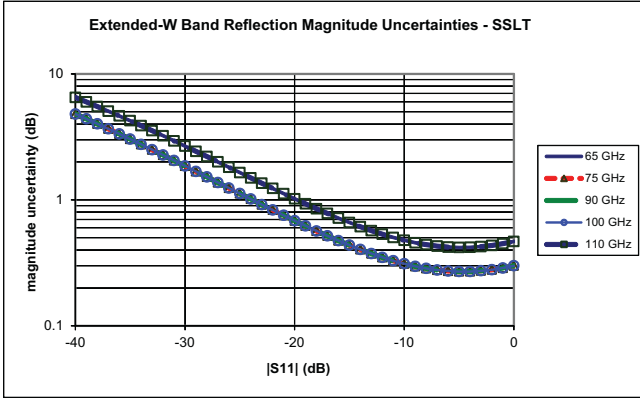

Measurement Uncertainties – Extended-W Band – LRL

The graphs give measurement uncertainties after the above calibration. The errors are worst case contribution of residual directivity, load and source match, frequency response and isolation, network analyzer dynamic accuracy, and connector repeatability. 10 Hz IF Bandwidth is used. For transmission uncertainties, it is assumed that $s_{11} = s_{22} = 0$. For reflection uncertainties, it is assumed that $s_{21} = s_{12} = 0$. All calibrations and measurements were performed at default port power. For other conditions, please use our free Exact Uncertainty Calculator software, available for download from the Anritsu website at www.anritsu.com. Typical.

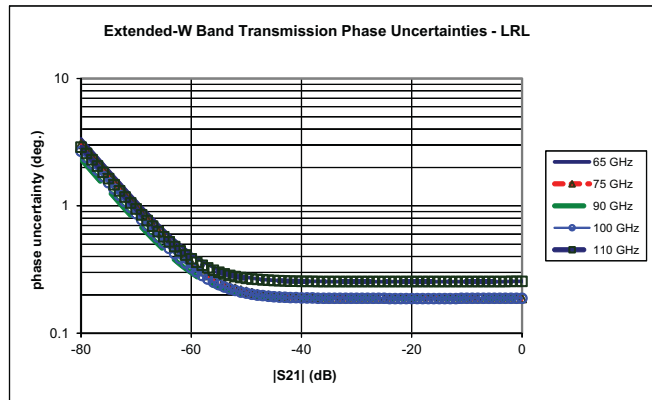
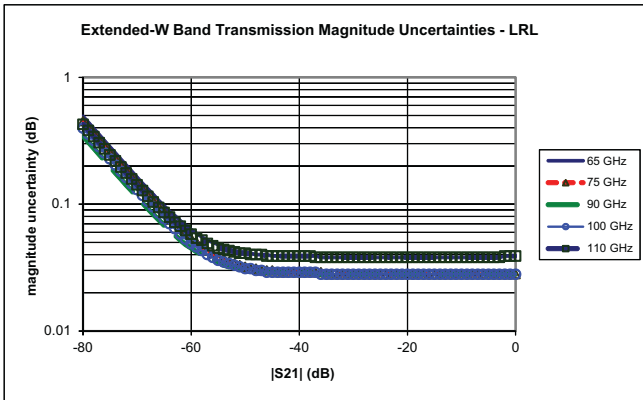
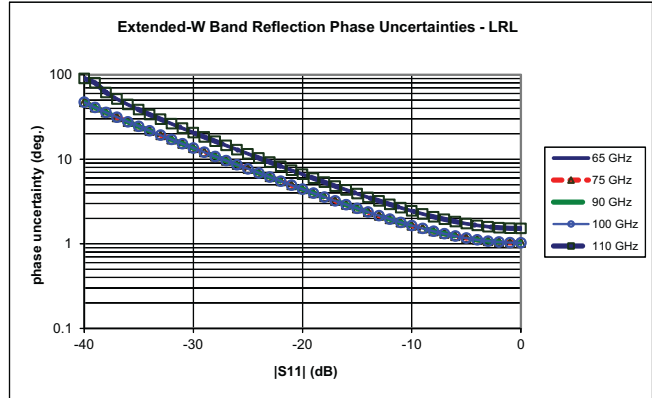
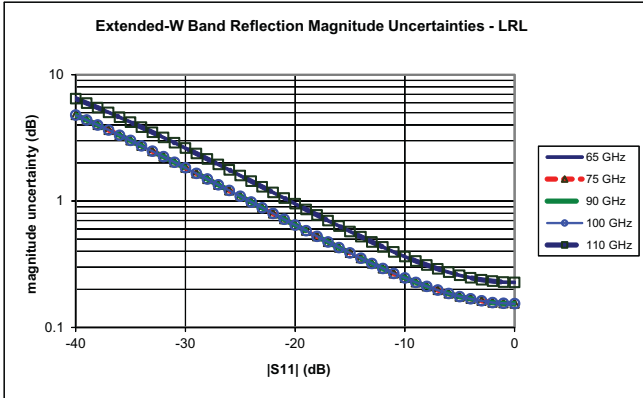

3.5 ME7838A with Option 041 and 3744A-Rx mm-Wave Noise Figure Measurements

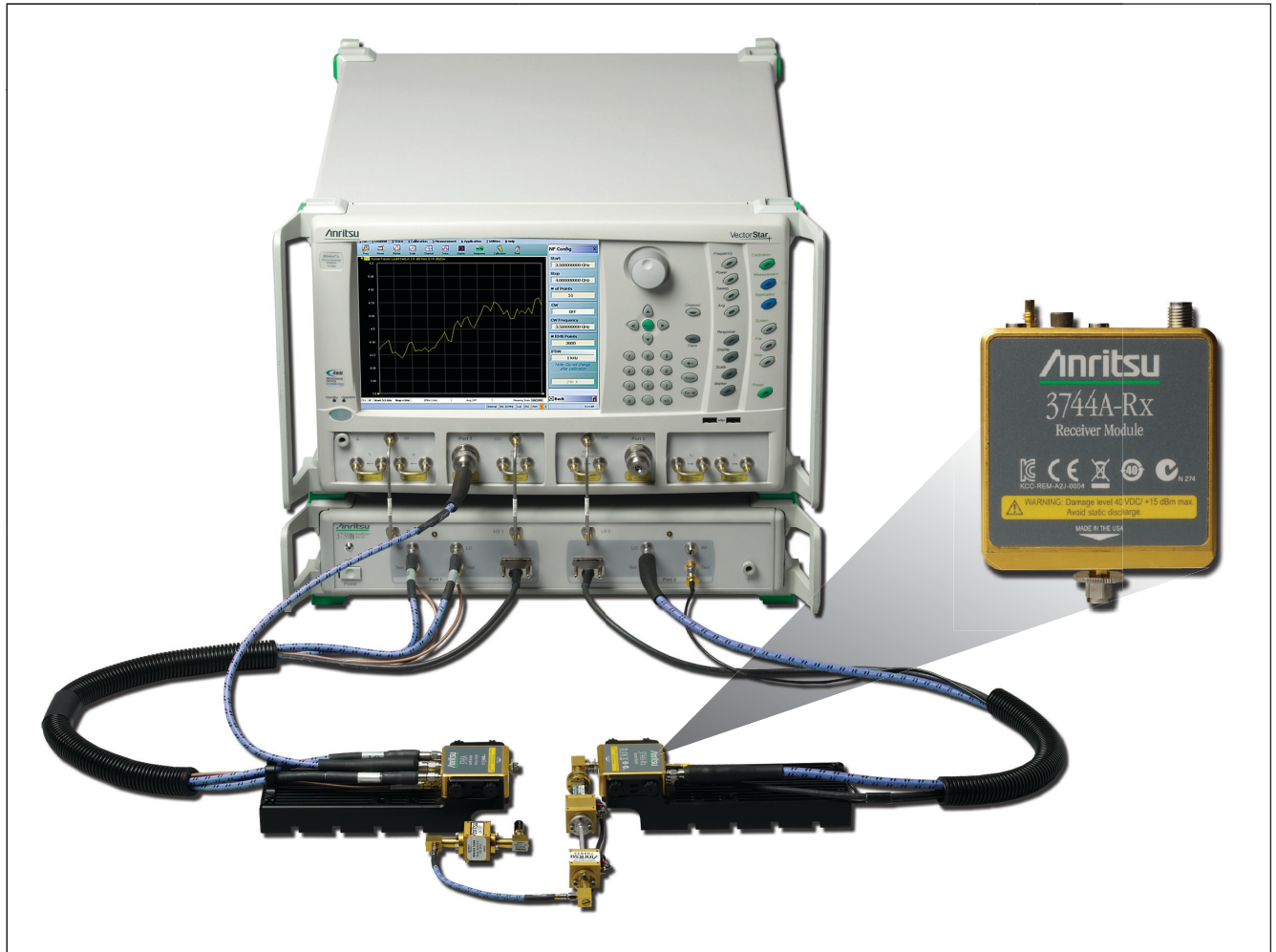

ME7838A with 3744A-Rx Receiver Module

The 3744A-Rx receiver module can be used with Option 041, Noise Figure, and the ME7838A mm-Wave or broadband system to perform mm-Wave noise figure measurements from 30 GHz to 125 GHz. The receiver bypasses the internal couplers (see block diagram), maximizing the noise figure of the receiver for optimum noise figure measurement accuracy. The receiver is derived from the 3743A mm-Wave module and utilizes the same nonlinear transmission line technology for optimum mm-Wave performance. Using the advantages of the 3743A mm-Wave module system architecture provides a unique solution to mm-Wave noise figure measurements previously unavailable.

3.6 Block Diagram – 3744A Receiver Module

As with all cold source method noise figure measurements, the output of the DUT is first sent to an external composite receiver for pre-amplification. This ensures that the system noise figure is minimized for optimum measurement accuracy. The Anritsu Noise Figure Uncertainty Calculator (available on the website at www.anritsu.com) can be used to determine optimum preamplifier gain needed for the desired measurement uncertainty.

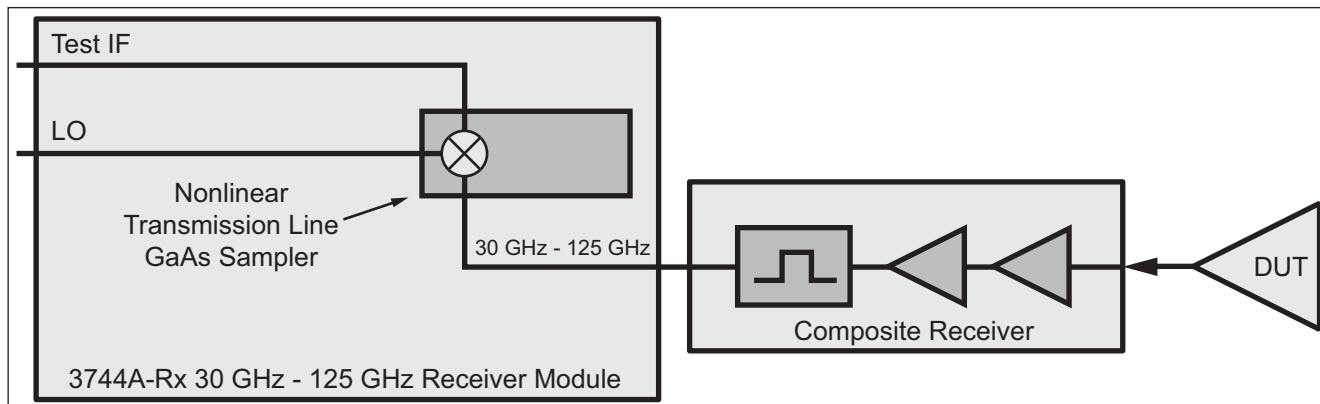

3744A-Rx Block Diagram

3.7 3744A-Rx Receiver Compression, Noise Floor

Receiver Compression Point is defined as the port power level beyond which the response may be compressed more than 0.2 dB relative to the normalization level. 10 Hz IF bandwidth is used to remove trace noise effects. All typical.

Noise Floor is relative to the receiver power calibration performed at -10 dBm. Typical.

Frequency	Receiver Compression (dBm) ^a	Noise Floor (dBm) ^b
30 to 54 GHz	0	-124
54 to 60 GHz	0	-122
60 to 67 GHz	0	-117
67 to 80 GHz	0	-120
80 to 85 GHz	0	-123
85 to 90 GHz	0	-121
90 to 95 GHz	0	-121
95 to 105 GHz	0	-117
105 to 110 GHz	0	-122
110 to 120 GHz	-5	-120
120 to 125 GHz	-5	-117

a. At the 3744A-Rx test port.

b. Excludes localized spurious responses and crosstalk.

4. VectorStar ME7838A Waveguide Bands from 50 GHz to 750 GHz (1.1 THz)

The VectorStar Millimeter-Wave system supports OML or VDI modules starting at 50 GHz. System performance is based on the specific mm-Wave module installed and appropriate cal kit. Contact the vendor web site for additional information.

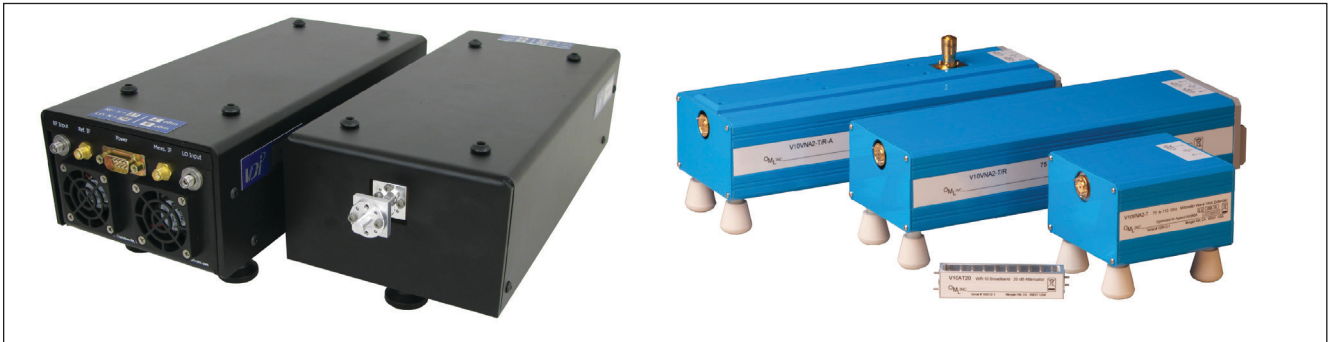

VDI and OML Millimeter-Wave Modules

4.1 Block Diagram – Millimeter-Wave VNA System

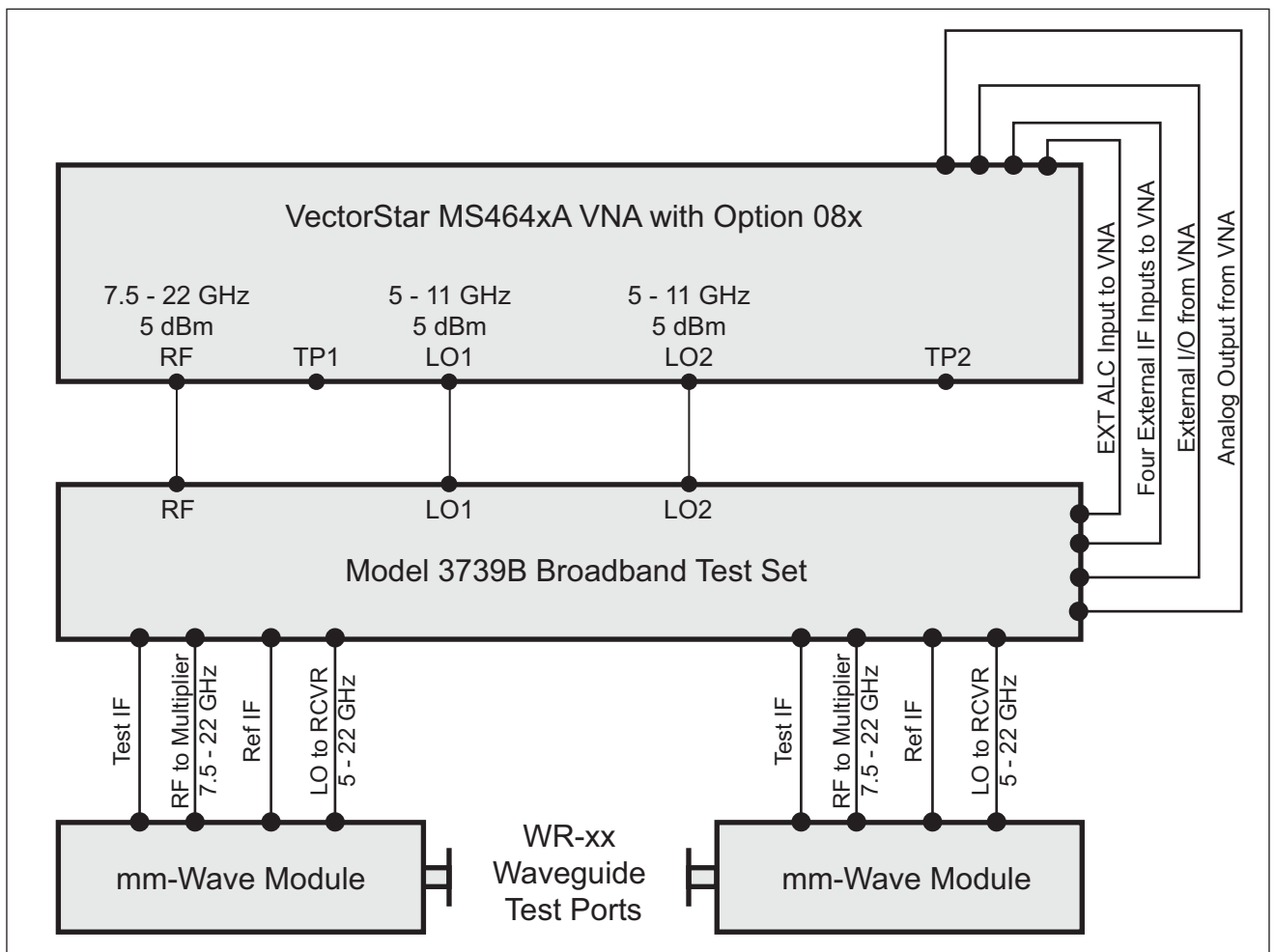

Millimeter-Wave Configuration Block Diagram

4.2 VectorStar ME7838A Millimeter-Wave System with VDI Modules

This section provides the specifications for the VectorStar MS4640A series microwave Vector Network Analyzers (VNAs) when configured with the Virginia Diodes, Inc. millimeter-wave (mm-Wave) frequency extension modules. The following frequency bands are supported:

Waveguide Band	WR15	WR10	WR8.0	WR6.5	WR5.1	WR4.3	WR3.4	WR2.8	WR2.2	WR1.5	WR1.0 ^a
Frequency (GHz)	50 to 75	75 to 110	90 to 140	110 to 170	140 to 220	170 to 260	220 to 400	260 to 400	325 to 500	500 to 750	750 to 1100

a. Contact Anritsu

4.3 System Configuration with VDI Modules

The VectorStar Millimeter-Wave system provides control of VDI modules for frequency extension coverage up to 750 GHz and beyond. MS4640A series VectorStar VNA may be configured for mm-Wave operation by adding the appropriate control option and test set. System requirements include:

- MS4642A, MS4644A, MS4645A, or MS4647A Model VectorStar VNA
- MS4640A Option 007, Receiver Offset
- MS4640A Option 080, 081, 082, or 083
- SM6537 Interface Cable
- 3739B Test Set

Each VDI module is equipped with a dedicated external power supply and DC cable. Connection between VectorStar and the VDI mm-Wave module is provided with the supplied interface cable.

4.4 VDI Module Specifications

Dynamic range and stability specifications are valid for any MS4640A VectorStar VNA with appropriate options. Directivity specifications are valid when using appropriate VDI calibration kits.

Waveguide Band (GHz)	VDI Millimeter-Wave Extenders Summary Specifications ^a										
	Band / Frequency Range (GHz)										
	WR15 50-75	WR10 75-110	WR8.0 90-140	WR6.5 110-170	WR5.1 140-260	WR4.3 170-260	WR3.4 220-325	WR2.8 260-400	WR2.2 325-500	WR1.5	
										500-700	700-750
Dynamic Range ^b	120	120	120	120	120	110	100	100	100	100	90
Minimum Dynamic Range ^c	100	100	90	90	90	85	80	80	80	80	75
Magnitude Stability (\pm dB)	0.15	0.15	0.15	0.25	0.25	0.3	0.3	0.5	0.5	0.8	0.8
Phase Stability (\pm deg.)	2	2	2	4	4	6	6	8	8	10	11
Test Port Power (dBm)	3	3	0	0	-3	-6	-9	-16	-17	-25	-25
Directivity (dB)	30	30	30	30	30	30	30	30	30	30	30
Maximum Dimensions ^d	11x5x3	11x5x3	11x5x3	11x5x3	11x5x3	11x5x3	11x5x3	11x5x3	11x5x3	11x5x3	11x5x3

a. Specifications. These results assume a through measurement with two TxRx Heads. The specifications quoted here are "expected" and subject to change. Stability is for 1 hour after a 1 hour warm-up, in a stable environment with ideal cables. The dynamic range (RBW 10 Hz) is measured by first connecting two TxRx heads together and normalizing the un-calibrated S_{21} . The heads are then disconnected and terminated with a waveguide load. The RMS of the measured S_{21} parameter is the system dynamic range.

b. Typical. BW = 10 Hz, dB, typical.

c. Typical. BW = 10 Hz, dB, minimum.

d. Dimensions: L x W x H dimensions in inches.

4.5 VDI Module Head Configurations

- TxRx Transmitter with two Receivers (Reference and Measurement), and two couplers. Two TxRx heads are required for full two-port measurements.
- TxRef Transmitter with Reference Receiver and one coupler.
- Rx Measurement Receiver.

4.6 VDI Module Options

Options available for millimeter-wave extenders are listed below:

Micrometer-Drive Variable Attenuator	A 0 dB to 30 dB micrometer-drive variable attenuator option is available on TxRx and Tx modules up through WR2.2. If ordered, "-Attn" is added as an option suffix to the module model number.
Increased Test Port Power	Options exist for increasing test port power in some full bands or in partial bands. Consult factory for more information.
Non-Standard Frequency Bands	Non-standard frequency bands are possible. Consult factory for more information.
Custom Configuration	Anritsu/VDI will work with customers to reconfigure any extender to meet specific needs.

4.7 ME7838A Measurement Examples Using VDI Millimeter-Wave Modules

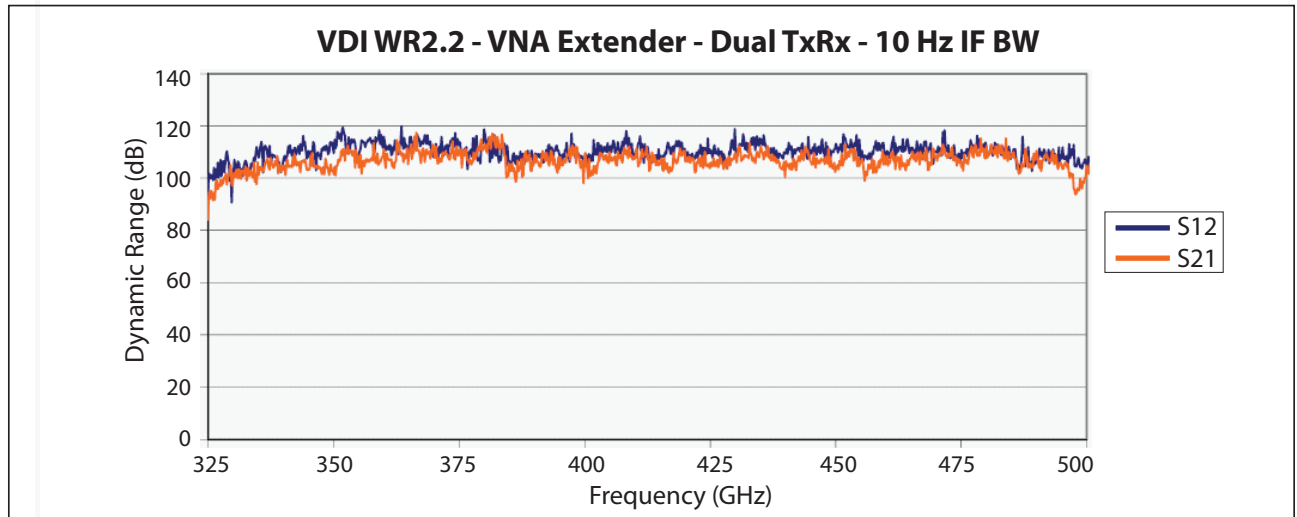

Dynamic Range Plot of VDI WR2.2 Module – 10 Hz IFBW

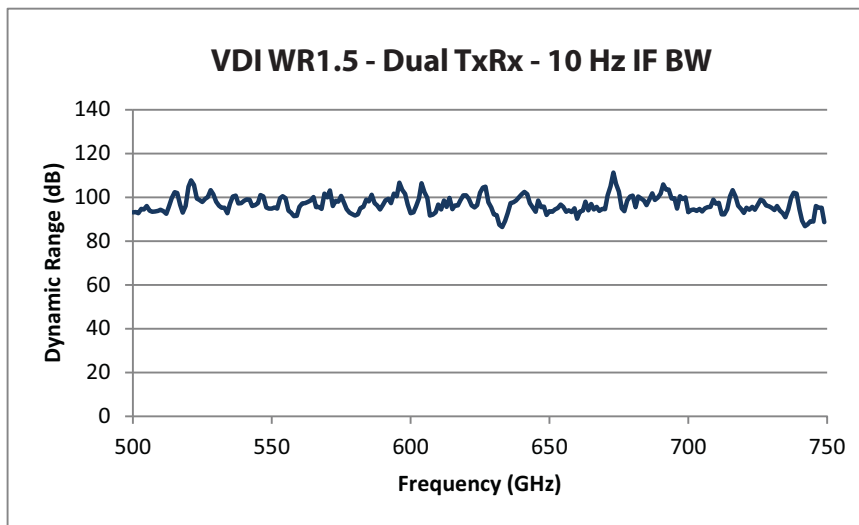

Dynamic Range Plot of VDI WR1.5 Dual TxRx – 10 Hz IFBW

ME7838A 400 GHz Power Sweep with VDI WR2.2 TxRx Module

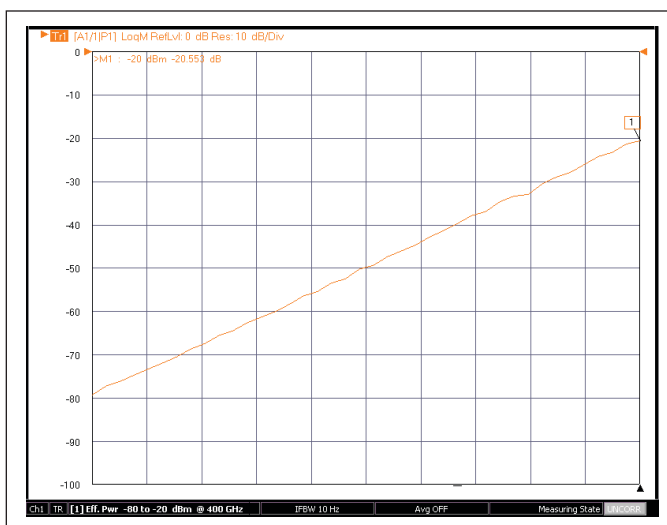

Real time power sweep of VDI WR2.2 module using system power level control and no mechanical attenuators.

4.8 VectorStar ME7838A Millimeter-Wave System with OML Modules This section provides specifications for the VectorStar MS4640A series microwave Vector Network Analyzers (VNAs) when configured with the OML millimeter-wave frequency extension modules.

Description	Each OML module must be equipped with a dedicated external power supply and DC cable. Connection between the VectorStar and the OML mm-Wave module is provided with the supplied interface cable.
System Configuration	The VectorStar Millimeter-Wave system provides control of OML modules for frequency extension coverage up to 325 GHz. The MS4640A series VectorStar VNA may be configured for mm-Wave operation by adding the appropriate control option and test set.
System requirements	MS4642A, MS4644A, MS4645A, or MS4647A Model VectorStar VNA MS4640A Option 007, Receiver Offset MS4640A Option 080, 081, 082, or 083 SM6537 Interface Cable 3739B Test Set
Specifications	Dynamic range specifications are valid for any MS4640A VectorStar VNA with appropriate options. Directivity specifications are valid when using appropriate OML calibration kits.

4.9 OML Millimeter-Wave Extenders Summary Specifications Specifications are typical and subject to change without notice.

OML "T/R" Models		V15VNA2-T/R	V12VNA2-T/R	V10VNA2-T/R	V08VNA2-T/R	V06VNA2-T/R	V05VNA2-T/R	V03VNA2-T/R
System Operating Frequency^a	(GHz)	WR-15 50 – 75	WR-12 60 – 90	WR-10 75 – 110	WR-08 90 – 140	WR-06 110 – 170	WR-05 140 – 220	WR-03 220 – 325
Test Port Output Power^b	Minimum Typical (dBm)	+5 +8	+2 +5	+3 +5	-8 -4	-15 -10	-18 -13	-23 -
Test Port Input Power @ 0.1 dB Compression^c	Typical (dBm)	+8	+8	+6	+4	-5	-5	-5
Test Port Match^c	Typical (dB)	> 17	> 17	> 17	> 17	> 15	> 15	> 9
Residual Source & Load Match	Typical (dB)	> 35	> 35	> 35	> 35	> 35	> 35	> 33
Test Dynamic Range^d	Minimum Typical (dB)	92 > 105	92 > 105	95 > 110	90 > 105	80 > 95	80 > 95	60 > 75
Reflection & Transmission Tracking^e	Magnitude (dB) Phase (deg.)	± 0.2 ± 2	± 0.2 ± 2	± 0.2 ± 2	± 0.3 ± 3	± 0.4 ± 5	± 0.4 ± 6	± 0.4 ± 8
Coupler Directivity^c	Typical (dB)	> 35	> 35	> 35	> 33	> 30	> 30	> 30
Size^f	(L x W x H)	13.0" x 4.3" x 2.7"						

a. Test Port Flange Configuration is compatible with MIL-DTL-3922/67D (UG 387/U-M)

b. As there are no internationally recognized power standards above 110 GHz, any power data supplied above 110 GHz is traceable only to OML's calorimeter.

c. Not Tested

d. Measured at 10 Hz IF bandwidth.

e. At +25 °C. Measured for 1 hr after 1 hr warm-up. Based on "perfect" RF and LO test cables not moved after warm-up and calibration. Not tested.

f. Height excludes the adjustable rubber feet; length and depth dimensions exclude the output waveguide length.

5. Standard Capabilities for All Configurations

For standard capabilities of the VectorStar VNAs, please see the **VectorStar MS4640A Series VNA Technical Data Sheet and Configuration Guide – 11410-00432**, available at www.anritsu.com.

6. Mechanical and Environmental

MS4640A Vector Network Analyzer Dimensions without rack mount option.

Height	267 mm body (6u) 286 mm between feet outer edges
Width	426 mm body 457 mm between feet outer edges 487 mm between front panel handles outer edges
Depth	502 mm body 591 mm between handle and foot outer edges
Weight	< 28 kg (< 60 lbs), Typical weight for a fully-loaded MS4647A VNA

3739B Broadband/Millimeter-Wave Test Set Dimensions without rack mount option.

Height	89 mm body (2u) 108 mm between feet outer edges
Width	426 mm body 457 mm between feet outer edges 487 mm between front panel handles outer edges
Depth	502 mm body 591 mm between handle and foot outer edges
Weight	5.75 kg

3743A Millimeter-Wave Module

Height	21.5 mm
Width	54 mm
Depth	55.3 mm
Weight	0.27 kg

Environmental – Operating

Temperature Range	Conforms to MIL-PRF-28800F (Class 3) 0 °C to +50 °C without error codes* * Except for 'unleveled' error messages that may occur at the extreme edges of the temperature range above.
Relative Humidity	5 % to 95 % at +40 °C, Non-condensing
Altitude	4,600 m (15,000 feet)

Environmental – Non-Operating

Temperature Range	-40 °C to +75 °C
Relative Humidity	0 % to 90 % at +65 °C, Non-condensing
Altitude	15,200 m (49,000 feet)
Relative Humidity	0 % to 90 % at +65 °C, Non-condensing

EMI

Meets the emissions and immunity requirements of:
 EN55011/2007 Class A, Group 1
 EN61000-4-2: 1998 (± 4 kV CD, 8k AD)
 EN61000-4-3: 2008 (80 MHz to 2700 MHz @ 3 V/m)
 EN61000-4-4: 2004 (500V SL, 1000V PL)
 EN61000-4-5: 2006 (2 kV L-E, 1 kV L-L)
 EN61000-4-6:2007 (0.15 MHz to 80 MHz, 3 V)
 EN61000-4-11:2004 (1 cycle, 100 %)

7. Calibration and Correction Capabilities

Calibration Methods	Short-Open-Load-Through (SOLT) with Fixed or Sliding Load Offset-Short Triple-Offset-Short Short-Open-Load-Reciprocal (SOLR) Reciprocal or Unknown Through Method Line-Reflect-Line (LRL) / Line-Reflect-Match (LRM) Advanced-LRM (A-LRM™) for improved on-wafer calibrations AutoCal With Thru Update available.
Correction Models	Full 12-term 1 Path / 2 Port Frequency Response (Transmission or Reflection, one or both directions) Reflection Only (1 Port or 2 Ports)
Merged Calibration	Merge multiple calibration methods over bands of frequency points.
Coefficients for Calibration Standards	
Load from USB Device	Load coefficients from USB Memory Device from your Anritsu calibration kit.
User-Defined	Enter manual coefficients into User-Defined locations.
Reference Impedance	Modify the reference impedance from 50 Ω to any impedance, excluding 0 Ω.
Interpolation	Allows interpolation between calibration frequency points, if selected
Adapter Removal Calibration	Characterizes and "removes" an adapter used during calibration that will not be used for subsequent device measurements, for accurate measurement of non-insertable devices.
Dispersion Compensation	Selectable as Coaxial, other non-dispersive (for example a coplanar waveguide), Waveguide, or Microstrip.
Power Calibrations	
Types	Flat Power Calibrations and Linear Power Calibrations (Power Meter Correction)
Enhanced Power Accuracy	Different power meter calibrations are available to enhance power accuracy at the desired reference plane (to usually ≈ 0.1 dB for short periods of time).
Flat Power Calibrations	Flat power calibrations (using the appropriate W1 adapter depending on the sensor) are available. Different power meters/sensors are required depending on the frequency range (above or below 70 GHz). Power level is user-selectable when within the power adjustment range of the internal source. Other power levels are then arrived at by offset transfers.
Linear Power Calibration	A linear power calibration is performed over a range of power levels for use in power sweep mode and is performed at a specified frequency or frequency range.
External Power Meter	Both calibrations are performed using an external power meter over the dedicated GPIB port.
Embedding/De-embedding	The MS4640A is equipped with an Embedding/De-embedding system.
De-embedding	De-embedding is generally used for removal of test fixture contributions, modeled networks and other networks described by S-parameters (s2p files) from measurements. An extraction utility is part of this package that allows the easier computation of de-embedding files based on some additional calibration steps and measurements.
Embedding	Similarly, the Embedding function can be used to simulate matching circuits for optimizing amplifier designs or simply adding effects of a known structure to a measurement.
Multiple Networks	Multiple networks can be embedded/de-embedded and changing the port and network orientations is handled easily.
Impedance Conversion	Allows entry of different impedances (complex values) for different ports.

8. Mechanical Calibration/Verification Kits

W1 (1 mm) Calibration/Verification Kit, 3656B

Provides 12-term SOLT or Triple Offset Short calibrations, for W1 (1 mm) devices, and two verification standards.

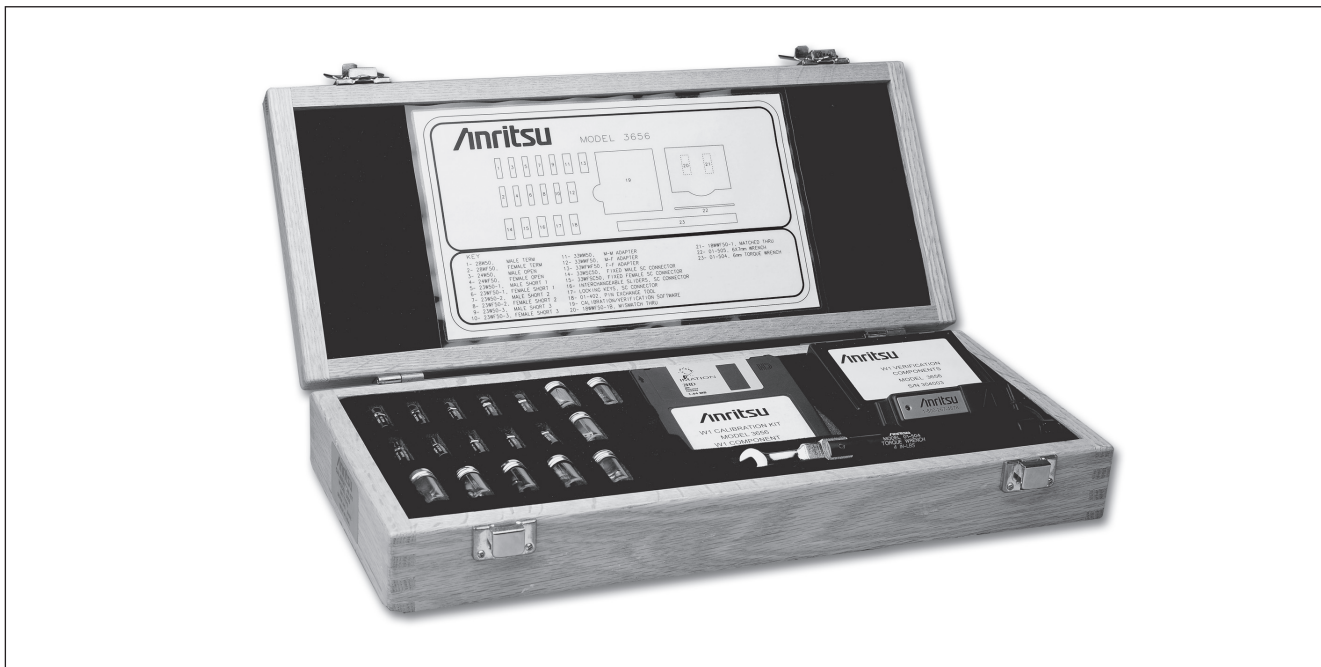

3656B W1 1 mm Calibration/Verification Kit providing 12-Term SOLT or SSST calibrations and two verification standards.

3656B Cal Kit Contains:	Additional Information (Typical)	Quantity	Part Number
Offset Short W1 (male)	Offset: 2.020 mm	1	23W50-1
Offset Short W1 (male)	Offset: 2.650 mm	1	23W50-2
Offset Short W1 (male)	Offset: 3.180 mm	1	23W50-5
Offset Short W1 (female)	Offset: 2.020 mm	1	23WF50-1
Offset Short W1 (female)	Offset: 2.650 mm	1	23WF50-2
Offset Short W1 (female)	Offset: 3.180 mm	1	23WF50-5
Open W1 (male)	Offset: 1.510 mm	1	24W50
Open W1 (female)	Offset: 1.930 mm	1	24WF50
Fixed Termination W1 (male)		1	28W50
Fixed Termination W1 (female)		1	28WF50
Adapter, W1 (male) to Fixed SC ^a Connector		1	33WSC50
Adapter, W1 (female) to Fixed SC ^a Connector		1	33WFSC50
Interchangeable Slider for SC ^a Connector (male)		1	-
Interchangeable Slider for SC ^a Connector (female)		1	-
Locking Keys for SC ^a Connectors		2	-
Pin Exchange Tool for SC ^a Connectors	Contains 1 male pin	1	01-402
Adapter, W1 (male) to W1 (female)		1	33WWF50
Adapter, W1 (male) to W1 (male)		1	33WW50
Adapter, W1 (female) to W1 (female)		1	33WFWF50
Stepped Impedance ThruLine, W1 (male - female)	Verification Device	1	18WWF50-1B
50 Ohm matched ThruLine, W1 (male - female)	Verification Device	1	18WWF50-1
Torque Wrench	6 mm, 5.4 N-cm (4 lbf-in)	1	01-504
Open-ended Wrench	6 mm / 7 mm	1	01-505
Coefficients for standards	On USB Memory Device and 3.5 in Floppy Disk	1	-

a. SC Connectors are a solution for accurate calibrations for non-insertable 1 mm devices. Users can change the gender of the SC connector using the provided tool, pin, sliders, and locking keys to ensure the best pin-depth, thus calibrations are valid after changing the gender of the adapter.

9. Test Port Cables

Test Port Cables, Flexible, High Performance

Description	Frequency Range	Impedance	Length (cm)	Insertion Loss (dB)	Return Loss (dB)	Part Number
W1 (1 mm) (male) to W1 (1 mm) (female)	DC to 110 GHz	50 Ω	10	1.74	≥ 14	3671W1-50-1
			13	2.23	≥ 14	3671W1-50-2
			16	2.74	≥ 14	3671W1-50-3



3671W1-50-X Flexible Test Port Cables

10. Precision Adapters, Attenuators, and Other Components

Anritsu offers a complete line of precision adapters and attenuators. For more information, please visit our web site at www.anritsu.com.



11. Warranty

The ME7838A Series VNAs and related accessories offer a 1 year warranty from the date of shipment. Please contact your local service center for additional warranty coverage. Note that the key component of the system, the MS4640A VNA, is covered by a 3-year standard warranty.

12. Ordering Information

The ME7838A Broadband/Millimeter-Wave VNA System provides single sweep coverage from 70 kHz to 110 GHz and consists of the following standard components and optional accessories, which are described in the sections below:

12.1 ME7838A Broadband System, 70 kHz to 110 GHz

Action	Part Number and Description	Additional Information
Order the base VectorStar model with the listed options:	<ul style="list-style-type: none"> MS4647A, 70 kHz to 70 GHz VNA MS4640A-007, receiver offset MS4640A-070, 70 kHz frequency coverage 3739B, broadband test set with 36 inch interface cables 3743A, Millimeter-Wave, 2 each ME7838A-SS020, On-site system assembly and verification 	
Include one of the following:	<ul style="list-style-type: none"> MS4647A-080, MS4647A with ME7838A system option OR <ul style="list-style-type: none"> MS4647A-081, MS4647A with ME7838A system option and Option 051 or 061 or 062 	
Include one of the following:	<ul style="list-style-type: none"> 806-206, 1.85mm phase stable VNA RF cables, 24", M-F, 2 each OR <ul style="list-style-type: none"> 806-209, 1.85mm phase stable VNA RF cables, 36", M-F, 2 each 	
Additional Options:	<ul style="list-style-type: none"> MS4640A-001, MS4640A rack mount 3739B-001, 3739B rack mount MS4640A-002, Time domain 	
	<ul style="list-style-type: none"> MS4647A-051, External VNA loops MS4647A-061, Active measurement suite, 2 attenuators MS4647A-062, Active measurement suite, 4 attenuators 	Must be ordered with option MS4647A-081

12.2 ME7838A Waveguide-Band System to 110 GHz – 3744A-EE or 3744A-EW mm-Wave Modules

Configurator for ME7838A Millimeter-Wave System using 3744A-EE or 3744A-EW mm-Wave Modules:

Action	Part Number and Description	Additional Information
Choose and order one of the three base VectorStar models with options listed:	<ul style="list-style-type: none"> MS4644A VNA, 10 MHz to 40 GHz MS4640A-007 MS4644A-082 or MS4644A-083 	MS4644A-083 is ordered when options 051, 061, or 062 are included.
	<ul style="list-style-type: none"> MS4645A VNA, 10 MHz to 50 GHz MS4640A-007 MS4645A-082 or MS4645A-083 	MS4645A-083 is ordered when options 051, 061, or 062 are included.
	<ul style="list-style-type: none"> MS4647A VNA, 10 MHz to 70 GHz MS4647A-007 MS4647A-080 or MS4647A-081 	MS4647A-081 is ordered when options 051, 061, or 062 are included.
Add options if desired:	<ul style="list-style-type: none"> Include Options 051, 061, or 062 	Options 061 and 062 include the Active Measurement Suite
	<ul style="list-style-type: none"> MS4640A-070 for 70 kHz operation in base VNA 	
	<ul style="list-style-type: none"> MS4640A-002 for Time Domain MS4640A-041 for Noise Figure 	
Order:	<ul style="list-style-type: none"> 3739B mm-Wave Test Set 	
Choose Extended-E or Extended-W Band Modules:	<ul style="list-style-type: none"> 3744A-EE, 56 GHz to 94 GHz Extended E Band module, 2 each 	
	<ul style="list-style-type: none"> 3744A-EW, 65 GHz to 110 GHz Extended W Band module, 2 each 	

Accessories

- 35WR12WF-EE Precision Waveguide to Coax Adapter Kit, 56 GHz to 94 GHz, WR-12 to W1 (f)
- 35WR10WF-EW Precision Waveguide to Coax Adapter Kit, 65 GHz to 110 GHz, WR-10 to W1 (f)

12.3 ME7838A Waveguide-Band System – Anritsu 3740/41A; OML; VDI mm-Wave Modules

ME7838A Waveguide-band System using Anritsu 3740/41A, OML, or VDI Millimeter-Wave modules:

Action	Part Number and Description	Additional Information
Choose and order one of the three base VectorStar models with options listed:	<ul style="list-style-type: none"> MS4642A VNA, 10 MHz to 20 GHz MS4640A-007 Receiver Offset MS4642A-082 or MS4642A-083 	MS4642A-083 is ordered when options 051, 061, or 062 are included.
	<ul style="list-style-type: none"> MS4644A VNA, 10 MHz to 40 GHz MS4640A-007 Receiver Offset MS4644A-082 or MS4644A-083 	MS4644A-083 is ordered when options 051, 061, or 062 are included.
	<ul style="list-style-type: none"> MS4645A VNA, 10 MHz to 50 GHz MS4640A-007 Receiver Offset MS4645A-082 or MS4645A-083 	MS4645A-083 is ordered when options 051, 061, or 062 are included.
	<ul style="list-style-type: none"> MS4647A VNA, 10 MHz to 70 GHz MS4647A-007 Receiver Offset MS4647A-080 or MS4647A-081 	MS4647A-081 is ordered when options 051, 061, or 062 are included.
Add options if desired:	<ul style="list-style-type: none"> Include Options 051, 061, or 062 	Options 061 and 062 include the Active Measurement Suite
	<ul style="list-style-type: none"> MS4640A-070 for 70 kHz operation in base VNA 	
	<ul style="list-style-type: none"> MS4640A-002 for Time Domain 	
Order:	<ul style="list-style-type: none"> 3739B mm-Wave test set 	
	<ul style="list-style-type: none"> SM6600 Interface Cables for Anritsu 3740/41A mm-Wave Modules SM6537 Interface Cables for OML/VDI mm-Wave Modules 	Does not include DC cable. DC supply is provided by mm-Wave module power supply.
Choose one of the two appropriate millimeter-wave module combinations:	<ul style="list-style-type: none"> 2 each TxRx transmission and reflection millimeter-wave modules 	Choose appropriate OML or VDI modules. Contact Anritsu Company for ordering information.
	<ul style="list-style-type: none"> 1 each TxRx transmission and reflection module, and 	
	<ul style="list-style-type: none"> 1 each Tx transmission only module 	

Accessories

SC8215	Kelvin Bias Tee 70 kHz to 110 GHz, Max Voltage: 16 VDC, Max Current: 100 mA
SC7287	Kelvin Bias Tee 100 MHz to 110 GHz, Max Voltage: 50 VDC, Max Current: 500 mA
SC8218	Triax (male) to SMC (male) Cable, (Inner-shield floating at SMC end), 1.5 m (60 in) long two (2) needed per Kelvin Bias Tee
ML2437A	Power Meter, Single Channel, for flat test port power calibration
SC7770	Thermal Sensor, with special characterization, 70 kHz to 70 GHz, V (female)
SM6494	System floor console. Includes larger size writing table
2100-1	GPIB cable, 1 m (39 in) long
2100-2	GPIB cable, 2 m (79 in) long
2100-4	GPIB cable, 4 m (157 in) long
806-206	1.85 mm cable, 61 cm (24 in) long, for connecting the VNA and the 3743A Modules
806-209	1.85 mm cable, 91 cm (36 in) long, for connecting the VNA and the 3743A Modules
01-201	Torque Wrench (for tightening male devices), 8 mm (5/16 in), 0.9 N·m (8 lbf·in) for SMA, 3.5 mm, 2.4 mm, K, and V connectors
01-202	Universal Test Port Connector Wrench
01-203	Torque Wrench (for tightening the VNA test ports to female devices) 20.6 mm (13/16 in), 0.9 N·m (8 lbf·in)
01-204	Anritsu Stainless Steel Connector Wrench, circular, open-ended for SMA, 3.5 mm, 2.4 mm, K and V connectors

Calibration/Verification Kits

3656B	W1 (1 mm) Calibration/Verification Kit
3655V	WR-15 Waveguide Calibration Kit, Without Sliding Loads
3655V-1	WR-15 Waveguide Calibration Kit, With Sliding Loads
3655E	WR-12 Waveguide Calibration Kit, Without Sliding Loads
3655E-1	WR-12 Waveguide Calibration Kit, With Sliding Loads
3655W	WR-10 Waveguide Calibration Kit, Without Sliding Loads
3655W-1	WR-10 Waveguide Calibration Kit, With Sliding Loads
3650A	SMA/3.5 mm Calibration Kit, Without Sliding Loads
3650A-1	SMA/3.5 mm Calibration Kit, With Sliding Loads
3652A	K Calibration Kit, Without Sliding Loads
3652A-1	K Calibration Kit, With Sliding Loads
3654D	V Calibration Kit, Without Sliding Loads
3654D-1	V Calibration Kit, With Sliding Loads
3657	V Multi-Line Calibration Kit, Without Shorts
3657-1	V Multi-Line Calibration Kit, With Shorts

Test Port Cables, Flexible, High Performance

3671W1-50-1	W1 (male) to W1 (female), 1 each, 10.0 cm (3.9 in)
3671W1-50-2	W1 (male) to W1 (female), 1 each, 13.0 cm (5.1 in)
3671W1-50-3	W1 (male) to W1 (female), 1 each, 16.0 cm (6.3 in)
3671KFS50-60	K (female) to 3.5 mm (male) cable, 60 cm (one cable)
3671KFK50-60	K (female) to K (male) cable, 60 cm (one cable)
3671KFK50-100	K (female) to K (male) cable, 1 each, 100 cm (one cable)
3671KFKF50-60	K (female) to K (female) cable, 1 each, 60 cm (once cable)
3671VVF50-60	V (female) to V (male) cable, 1 each, 60 cm (one cable)
3671VVF50-100	V (female) to V (male) cable, 1 each, 100 cm (one cable)
3671KFSF50-60	K (female) to 3.5 mm (female) cable, 1 each, 60 cm (one cable)
3671VVFV50-60	V (female) to V (female) cable, 1 each, 60 cm (one cable)

Adapters and More

34WV50	W1 (male) to V (male) Adapter, W1 (1 mm) to V, Coaxial
34WVF50	W1 (male) to V (female) Adapter, W1 (1 mm) to V, Coaxial
34WV50	W1 (female) to V (male) Adapter, W1 (1 mm) to V, Coaxial
34WVVF50	W1 (female) to V (female) Adapter, W1 (1 mm) to V, Coaxial
33WW50	W1 (male) to W1 (male) Adapter, W1 (1 mm) in-series, Coaxial
33WVF50	W1 (male) to W1 (female) Adapter, W1 (1 mm) in-series, Coaxial
33WVVF50	W1 (female) to W1 (female) Adapter, W1 (1 mm) in-series, Coaxial
35WR10W	WR10 to W1 (male) Adapter, W1 (1mm) to WR10 Waveguide
35WR10WF	WR10 to W1 (female) Adapter, W1 (1mm) to WR10 Waveguide
SC7260	WR12 to W1 (male) Adapter, W1 (1 mm) to WR12 Waveguide
SC7442	WR12 to W1 (female) Adapter, W1 (1 mm) to WR12 Waveguide
35WR15V	WR15 to V (male) Adapter, V (1.85mm) to WR15 Waveguide
35WR15VF	WR15 to V (female) Adapter, V (1.85mm) to WR15 Waveguide
For More Information	Refer to our Precision RF & Microwave Components Catalog for descriptions of adapters and other components.



Find Drivers, Utilities, Software Updates, and other Helpful Tools at the VectorStar Users Site. Visit:
www.anritsu.com/en-us/Products-Solutions/Solution/Welcome-to-the-VectorStar-Users-Site-.aspx



To receive a quote to purchase a product or order accessories visit our online ordering site: www.ShopAnritsu.com

Training at Anritsu

Anritsu has designed courses to help you stay up to date with technologies important to your job. For available training courses visit:
www.anritsu.com/training



• United States

Anritsu Company

1155 East Collins Blvd., Suite 100,
Richardson, TX 75081, U.S.A.
Toll Free: 1-800-267-4878
Phone: +1-972-644-1777
Fax: +1-972-671-1877

• Canada

Anritsu Electronics Ltd.

700 Silver Seven Road, Suite 120,
Kanata, Ontario K2V 1C3, Canada
Phone: +1-613-591-2003
Fax: +1-613-591-1006

• Brazil

Anritsu Eletrônica Ltda.

Praça Amadeu Amaral, 27 - 1 Andar
01327-010 Paraisópolis, São Paulo, Brazil
Phone: +55-11-3283-2511
Fax: +55-11-3288-6940

• Mexico

Anritsu Company, S.A. de C.V.

Av. Ejército Nacional No. 579 Piso 9, Col. Granada
11520 México, D.F., México
Phone: +52-55-1101-2370
Fax: +52-55-5254-3147

• United Kingdom

Anritsu EMEA Ltd.

200 Capability Green, Luton, Bedfordshire LU1 3LU,
U.K.
Phone: +44-1582-433280
Fax: +44-1582-731303

• France

Anritsu S.A.

12 Avenue du Québec,
Bâtiment Iris 1-Silic 612,
91140 VILLEBON SUR YVETTE, France
Phone: +33-1-60-92-15-50
Fax: +33-1-64-46-10-65

• Germany

Anritsu GmbH

Nemetschek Haus, Konrad-Zuse-Platz 1
81829 München, Germany
Phone: +49-89-442308-0
Fax: +49-89-442308-55

• Italy

Anritsu S.r.l.

Via Elio Vittorini 129, 00144 Roma, Italy
Phone: +39-06-509-9711
Fax: +39-06-502-2425

• Sweden

Anritsu AB

Borgafjordsgatan 13A, 164 40 KISTA, Sweden
Phone: +46-8-534-707-00
Fax: +46-8-534-707-30

• Finland

Anritsu Finland

Teknobulevardi 3-5, 01530 Vantaa, Finland
Phone: +358-20-741-8100
Fax: +358-20-741-8111

• Denmark

Anritsu A/S (for Service Assurance)

Anritsu AB (for Test & Measurement)
Kay Fiskers Plads 9, DK-2300 Copenhagen S,
Denmark
Phone: +45-3691-5035
Fax: +45-7211-2210

• Russia

Anritsu EMEA Ltd.

Representation Office in Russia

Tverskaya str. 16/2, bld. 1, 7th floor.
Russia, 125009, Moscow
Phone: +7-495-363-1694
Fax: +7-495-935-8962

• United Arab Emirates

Anritsu EMEA Ltd.

Dubai Liaison Office

P O Box 500413 - Dubai Internet City
Al Thuraya Building, Tower 1, Suite 701, 7th Floor
Dubai, United Arab Emirates
Phone: +971-4-3670352
Fax: +971-4-3688460

• Singapore

Anritsu Pte. Ltd.

60 Alexandra Terrace, #02-08, The Comtech
(Lobby A)
Singapore 118502
Phone: +65-6282-2400
Fax: +65-6282-2533

• India

Anritsu India Pvt. Ltd.

2nd & 3rd Floor, #837/1, Binnamangla 1st Stage,
Indiranagar, 100ft Road, Bangalore - 560038, India
Phone: +91-80-4058-1300
Fax: +91-80-4058-1301

• P.R. China (Shanghai)

Anritsu (China) Co., Ltd.

Room 1715, Tower A CITY CENTER of Shanghai,
No.100 Yunyi Road, Chang Ning District,
Shanghai 200051, P.R. China
Phone: +86-21-6237-0898
Fax: +86-21-6237-0899

• Hong Kong

Anritsu Company Ltd.

Unit 1006-7, 10/F, Greenfield Tower,
Concordia Plaza,
No. 1 Science Museum Road, Tsim Sha Tsui East,
Kowloon, Hong Kong
Phone: +852-2301-4980
Fax: +852-2301-3545

• Japan

Anritsu Corporation

8-5, Tamura-cho, Atsugi-shi,
Kanagawa, 243-0016 Japan
Phone: +81-46-296-1221
Fax: +81-46-296-1238

• Korea

Anritsu Corporation, Ltd.

502, 5FL H-Square N B/D, 681
Sampyeong-dong, Bundang-gu, Seongnam-si,
Gyeonggi-do, 463-400 Korea
Phone: +82-31-696-7750
Fax: +82-31-696-7751

• Australia

Anritsu Pty Ltd.

Unit 21/270 Ferntree Gully Road, Notting Hill
Victoria, 3168, Australia
Phone: +61-3-9558-8177
Fax: +61-3-9558-8255

• Taiwan

Anritsu Company Inc.

7F, No. 316, Sec. 1, Neihu Rd., Taipei 114, Taiwan
Phone: +886-2-8751-1816
Fax: +886-2-8751-1817

List Revision Date: 20121126



© Anritsu All trademarks are registered trademarks of their respective companies. Data subject to change without notice. For the most recent specifications visit: www.anritsu.com
Anritsu prints on recycled paper with vegetable soybean oil ink.

ME7838A BB/mm-Wave VNA VectorStar TDS
Copyright May 2013 Anritsu Company, USA

All Rights Reserved



11410-00593



D